

# nexis<sup>®</sup>

Cannulated Screws



## OPERATIVE TECHNIQUE

MIDFOOT  
REARFOOT

Nexis<sup>®</sup> compressive screws  $\varnothing 5 / \varnothing 7$  mm

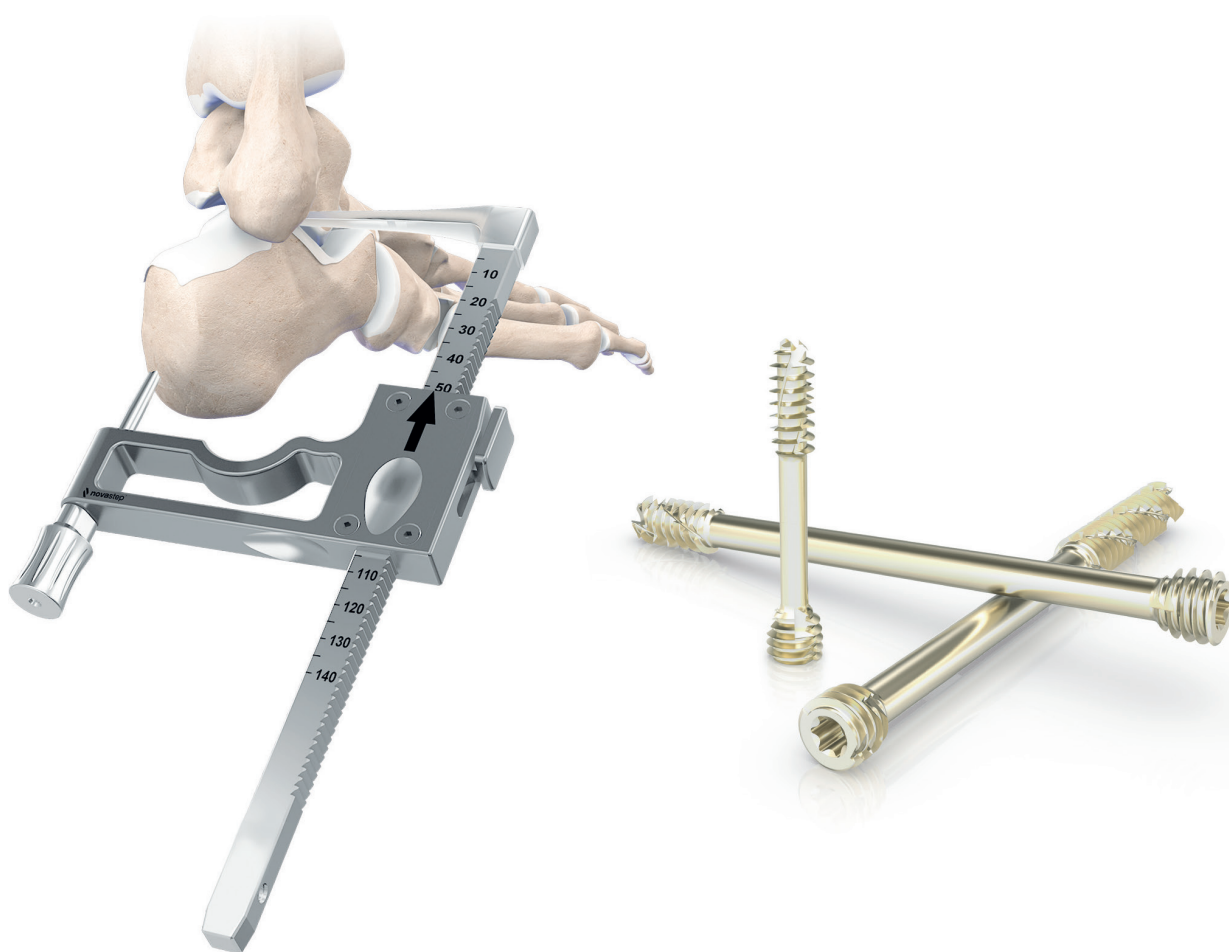

- . Self-drilling & helical self-tapping
- . Hexalobe recess headless screws
- . Optimized positioning: targeting & parallel guide

*Creating  
Better  
Together<sup>™</sup>*

## Table of contents

---

### Introduction

- 02 Indications
- 02 Contraindications

### Nexis<sup>®</sup> Ø 5 & Ø 7: Implants & Instruments

- 03 1 - Technical features
- 03 2 - Nexis<sup>®</sup> compressive screws Ø 5 / Ø 7 mm
- 04 3 - Instrumentation
- 07 4 - Nexis<sup>®</sup> Ø 5 / Ø 7 mm instructions for use
- 09 5 - Targeting guide & parallel wire guide instructions for use

### Surgical Technique

Example of use: Subtalar arthrodesis

- 12 1 - Incision & exposure
- 12 2 - Targeting guide set up
- 13 3 - K-wires positioning with targeting guide & parallel wire guide
- 14 4 - Screws insertion

### References

- 16 Nexis<sup>®</sup> compressive screws Ø 5 / Ø 7 mm
- 18 Rearfoot targeting guide
- 19 Nexis<sup>®</sup> screw Ø 4 mm
- 20 Arcad<sup>®</sup> compressives staples

# Introduction

The Nexis® Ø 5 and Ø 7 mm cannulated, self-drilling and self-tapping compressive screws, made of Titanium alloy, are designed to address midfoot and rearfoot indications.

Designed in partnership with an international panel of foot and ankle specialists, the Nexis® range offers **stable fixation**, a **substantial range of lengths**, and **insertion features**.

It is available with a **targeting guide** which allows for accurate and reliable K-wire placement.

## Indications & Contraindications

### Indications

The osteosynthesis screws are indicated for arthrosis, hallux valgus and other bone alignment defaults (pes cavus, flatfoot, malalignment secondary to previous trauma).

Examples of use:

#### Ø 5 mm:

- . Partial or complete Lisfranc arthrodesis
- . Talo-navicular fusion
- . Calcaneo-cuboid fusion
- . Lapidus procedure

#### Ø 7 mm:

- . Tibio-talar fusion
- . Subtalar fusion
- . Calcaneal osteotomy

### Contraindications

Osteosynthesis screws should not be used in case of any of the following:

- . Severe muscular, neurological or vascular deficiency in the extremity concerned.
- . Bone destruction or poor bone quality, likely to impair implant stability.
- . Hypersensitivity to vanadium and/or aluminium.

**Note:** Detailed information on each medical device is provided in the instruction for use. Refer to the instruction for use for a complete list of side effects, warnings, precautions for use, and directions for use.



# Nexis® Ø 5 & Ø 7: Implants & Instruments

## 1 - Technical features

### Nexis® Ø 5 / Ø 7 mm: The midfoot & rearfoot solution

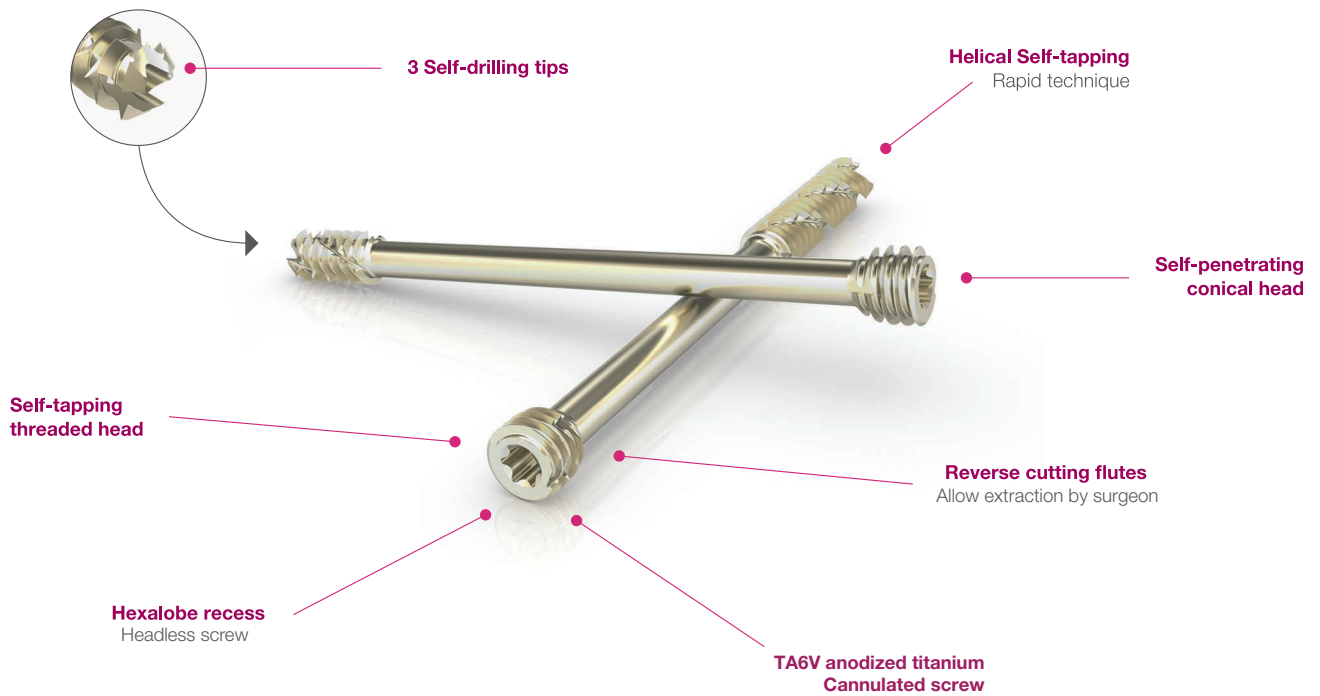

## 2 - Nexis® compressive screws Ø 5 / Ø 7 mm

	Ø5 nexis	Ø7 nexis
<b>Screwdriver Tip</b>	T20	T25
<b>Distal Thread Diameter</b>	Ø 5 mm	Ø 7 mm
<b>Distal Thread Length</b>	1/4 of the overall length	16 mm or 32 mm**
<b>Length</b>	30 - 100 mm*	40 - 120 mm***
<b>K-wire</b>	Ø 1.6 x 180 mm	Ø 2.2 x 200 mm

\* 2 mm increments up to 50 mm, then 5 mm increments.

\*\* Optional.

\*\*\* 5 mm increments.

# Nexis® Ø 5 & Ø 7: Implants & Instruments

## 3 - Instrumentation

### 3.1 - Modular, all-inclusive solution

The instrumentation set is fully modular and customizable with several modules to meet individual surgeon requirements.



### Ergonomic instrumentation

The Nexis® screws can be used with two types of handle: a large AO straight handle or a large AO T handle ratchet for optimum transmission of forces and with ratchet for fast screw insertion.



Large AO straight handle



Large AO T handle ratchet

# Nexis® Ø 5 & Ø 7: Implants & Instruments

Additional graduations on the tip of the ruler and of the T20 AO and T25 large AO screwdriver tips facilitate the identification of soft tissue depth, especially in MIS procedures.

Insert the ruler on the bone for K-wire measurement. In addition, read the depth in soft tissue. This value can be reported on the screwdriver graduated tip to make sure the screw head extremity is flush or lower than the bone cortex.

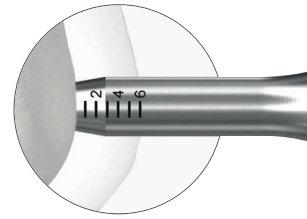

Graduated ruler tip



Graduated screwdriver tip

## Color code identification:

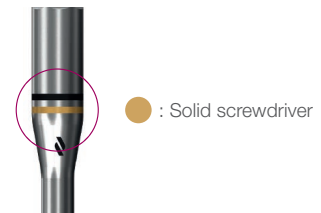
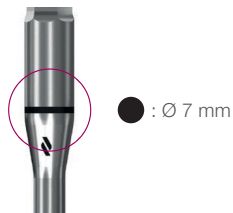
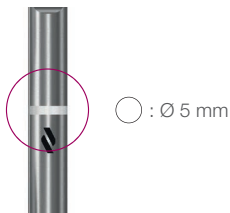

# Nexis® Ø 5 & Ø 7: Implants & Instruments

## 3.2 - Rearfoot targeting guide for Nexis® Ø 5 / Ø 7

Specifically designed for rearfoot indications, the rearfoot targeting guide acts as a clamp to allow for accurate K-wire placement.

### Features and advantages

#### Rearfoot targeting guide:

- Accurate K-wire placement, positioning entry and exit points.
- Increased accuracy when used in arthroscopic surgery.
- Optimized design with smoothed outer surface of the tip to preserve soft tissue.
- One handed adjustable instrument with trigger rack and pinion design.
- Toothed K-wire sleeve, provides adequate grip on the bone for good stability.
- Accurate screw lengths can be identified by the ruler in the targeting arm.

#### Parallel wire guide:

- Avoids any potential risk of conflict between two Nexis® Ø 5 / Ø 7 screws with a minimum inter-axis of 10 mm.
- Positioning of 2 parallel screws with an inter-axis from 10 to 30 mm.
- Adjustable position of the K-wire sleeve secured with a locking knob.

### Instruments in detail

#### ► Targeting guide for Nexis® Ø 5/Ø7 screws:

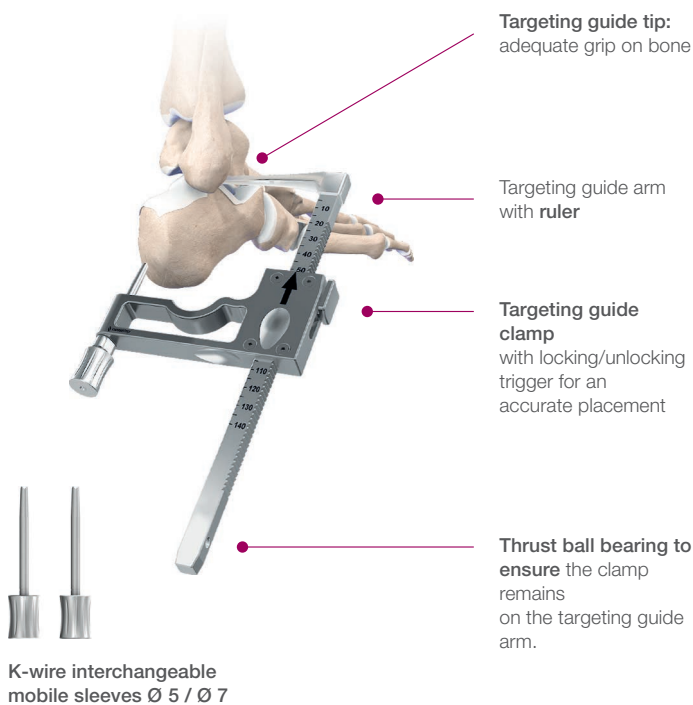

#### ► Parallel wire guide:

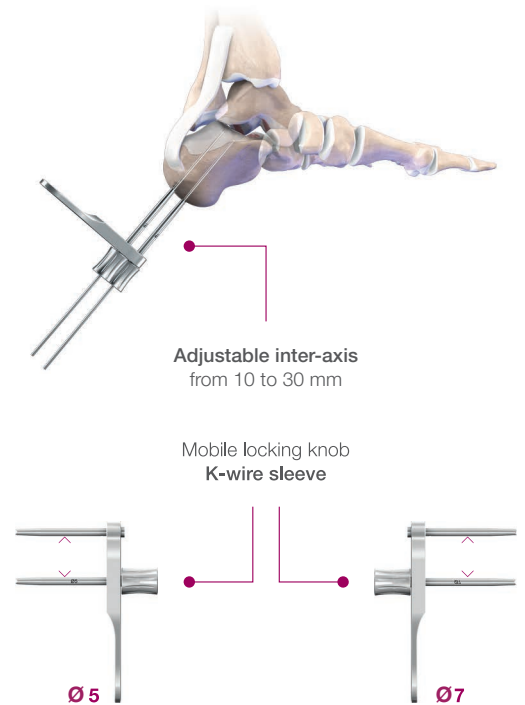

# Nexis® Ø 5 & Ø 7: Implants & Instruments

## 4 - Nexis® Ø 5 / Ø 7 instructions for use

### 1 - K-wire insertion

The K-wire can be inserted either with the Targeting guide or directly.

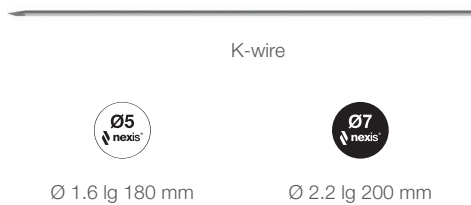

Double drill guide Nexis® Ø 5 or Nexis® Ø 7 can be used before K-wire insertion.



### 2 - Screw length assessment

A Nexis® ruler can be slid on the K-wire to identify appropriate screw length.

If the targeting guide has been used to position the K-wire, a direct reading of the length is possible on the graduated arm of the targeting guide, depending on the indications.

A screw length is typically 5 mm shorter than that indicated on the ruler.

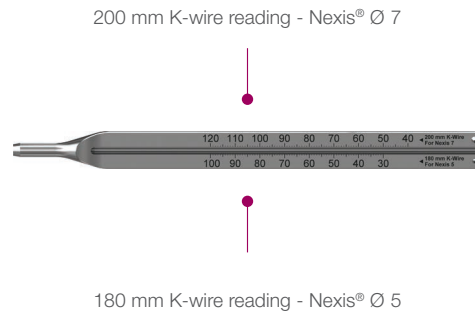

### 3 - Screw insertion

**Optional - Screw insertion preparation:** The self-drilling and self-tapping Nexis® screws are efficient in cancellous bone. In dense cortical bone, pre-drilling and/or countersink is recommended.

**Option 1 - Pre-drilling:** A graduated cannulated drill-bit can be used over the K-wire to drill. Direct reading of appropriate screw length is possible.



**Option 2 - Screw head preparation:** A cannulated countersink can be used either manually or preferably attached to the power driver.





# Nexis® Ø 5 & Ø 7: Implants & Instruments

The screw is inserted over the K-wire and screwed with the T20 or T25 AO screwdriver tip either manually or attached to the power driver, depending on surgeon's preferences. After correct screw placement, remove the guide wire.



**Optional - Screw removal:** Each screw has reversed cutting flutes easing the screw extraction. To remove an implanted screw, after cleaning out the screw head:

**Option 1:** Insert the adequate K-wire in the cannula of the screw and use the adequate AO screwdriver tip.

**Option 2:** Use the adequate solid screwdriver.



**Note:** Instruments can be connected to power or used manually attached to straight handle or T-handle. Adaptors are available in the Nexis® set to suit the power tools type available in the OR:

**Nexis® Ø 5 instrument:**



**Nexis® Ø 7 instrument:**

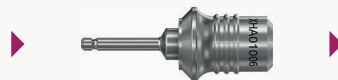

# Nexis® Ø 5 & Ø 7: Implants & Instruments

## 5 - Targeting guide and parallel wire guide instructions for use

### Instruction for use:

Unlock the clamp by pressing the button to move it forward or backward.

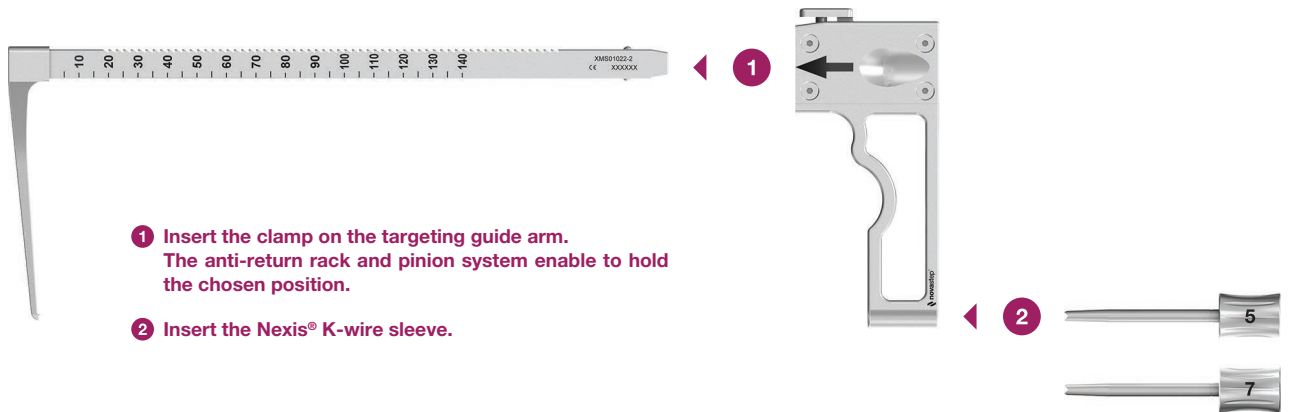

- 1 Insert the clamp on the targeting guide arm. The anti-return rack and pinion system enable to hold the chosen position.
- 2 Insert the Nexis® K-wire sleeve.

### Option:

Depending on the indicated use, direct reading of the needed screw length is possible.

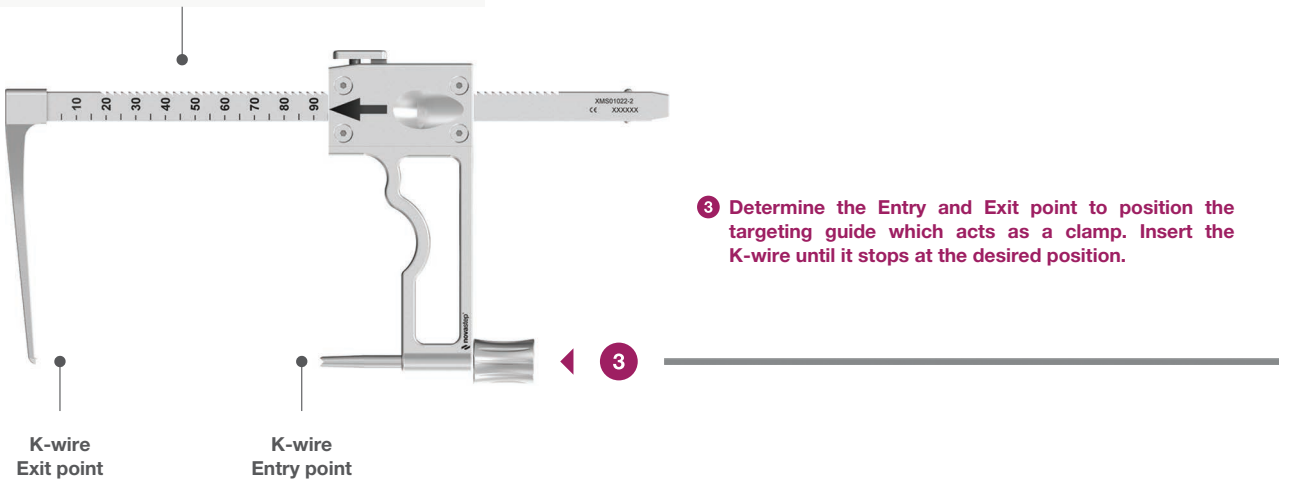

- 3 Determine the Entry and Exit point to position the targeting guide which acts as a clamp. Insert the K-wire until it stops at the desired position.

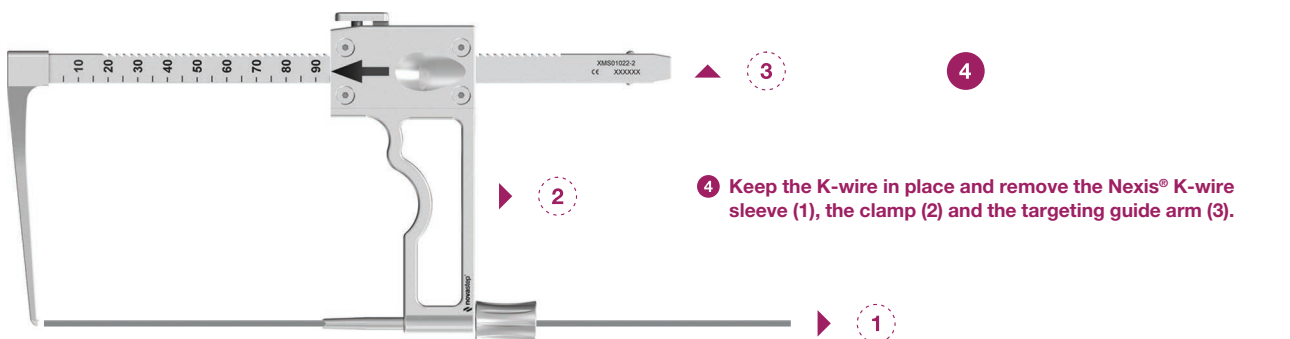

- 4 Keep the K-wire in place and remove the Nexis® K-wire sleeve (1), the clamp (2) and the targeting guide arm (3).

# Nexis® Ø 5 & Ø 7: Implants & Instruments

## Option: Two screws implantation with the parallel wire guide

- 5 After K-wire positioning, insert the parallel wire guide on the K-wire. Define the correct inter-axis (1) and lock the knob to secure the sleeve position (2).

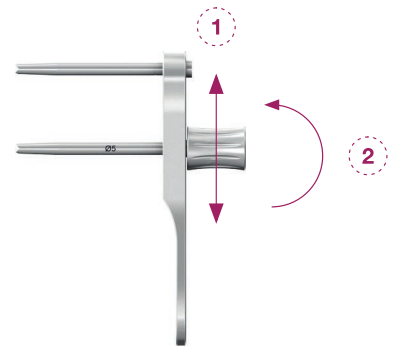

- 6 Insert the second K-wire in the sleeve. Remove the parallel wire guide to insert the Nexis® screws.

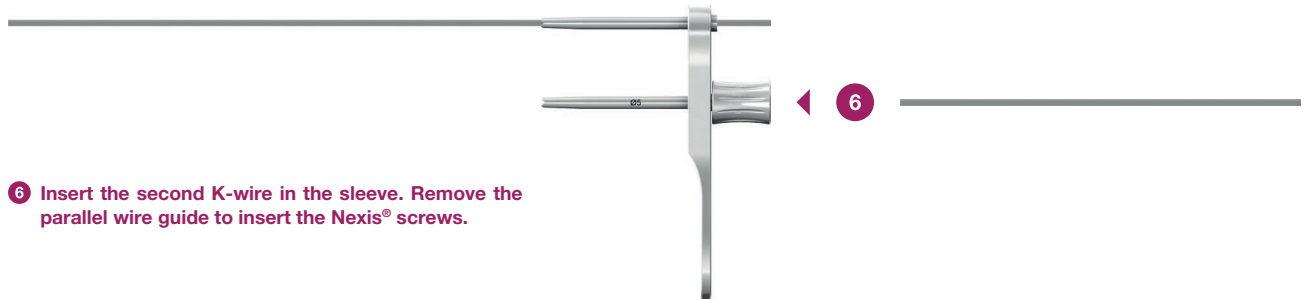

**Note:** Depending on the indications, the parallel wire guide can be used as standalone, without prior use of the targeting guide.

### Trick:

Insertion of 2 screws with different diameters. Nexis® Ø 5 parallel wire guide can be used over Ø 1.6 K-wire. Nexis® Ø 7 parallel wire guide can be used over Ø 2.2 K-wire.

If needed, it is possible to swap the mobile wire sleeves by unscrewing them off the parallel wire guide.

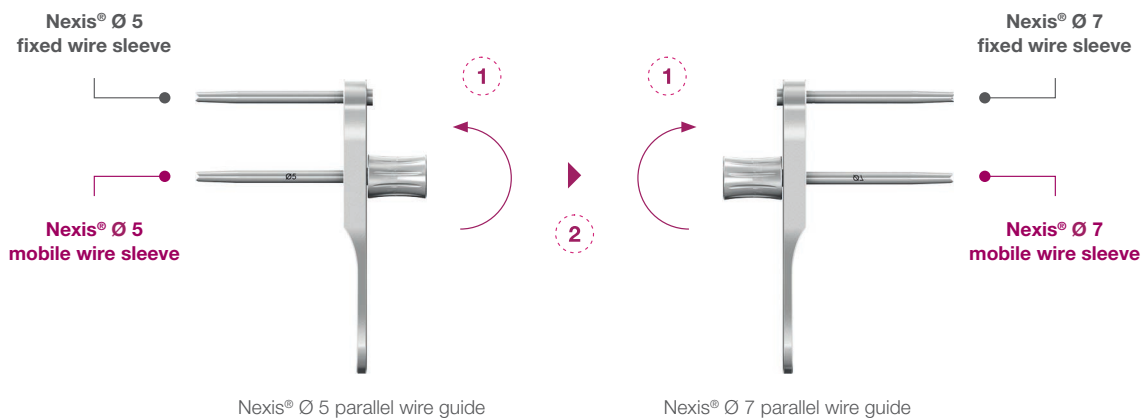

# Nexis® Ø 5 & Ø 7: Implants & Instruments

After K-wire positioning, follow the instructions for use of Nexis® screws (cf part 4).

**Cleaning / sterilization recommendation:** For appropriate cleaning of the instruments, disassemble all pieces. Remove the K-wire sleeve from the clamp and the clamp from the targeting guide arm. Unscrew the K-wire sleeve and remove it from the parallel guide.

## Indications

The rearfoot targeting guide aides in the following procedures:



Subtalar joint fusion

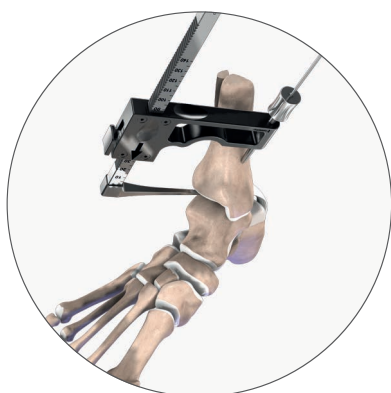

Tibiotalar fusion / Ankle fusion

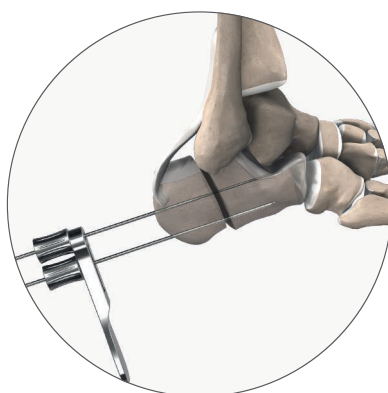

Calcaneal slide osteotomy

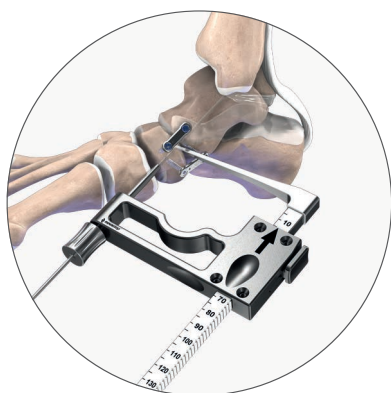

Talo-navicular fusion



Calcaneal-cuboid fusion

# Surgical Technique

Novastep® does not practice medicine and does not recommend this or any other surgical technique. Each surgeon must consider the specific needs of each patient and is responsible for making applicable adjustment and determining and using the appropriate technique for implanting the device in each cases.

## 1 - Example of use: Subtalar arthrodesis

---

Subtalar fusion surgical technique with two Nexis® Ø 7 screws implanted with the help of the targeting guide and parallel wire guide.

### 1 - Incision & exposure

Make a cut on the lateral aspect of the ankle and expose the subtalar joint. Position an open arms distractor between the calcaneus and the talus.

Sterile threaded k-wires are available for use with the distractor. Threaded K-wire tips provide adequate grip when compared to smooth k-wires which avoid retractor migration when distracting the joint.

Distract the joint to prepare the joint surfaces for fusion by removing the cartilage on superior aspect of the calcaneus and inferior aspect of the talus with an osteotome or a curette until arriving in the presence of bleeding subchondral bone.

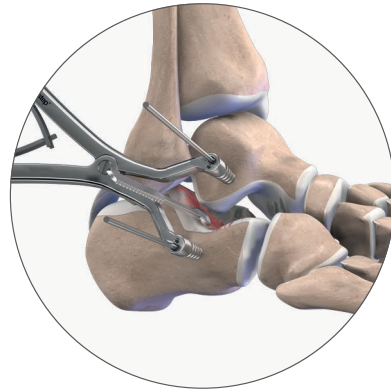

### 2 - Targeting guide set up

Assemble the targeting guide. Make a cut on the posterior aspect of the calcaneum, at the entry point level of the first K-wire. Position the tip of the targeting guide in the subtalar joint, at the desired exit point of the first K-wire.

Slide the clamp on the targeting guide arm to position the Nexis® Ø 7 K-wire sleeve in the incision. The no-return ratcheted system and pinion system maintain the clamp in place.

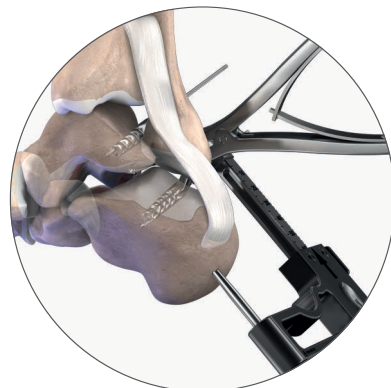
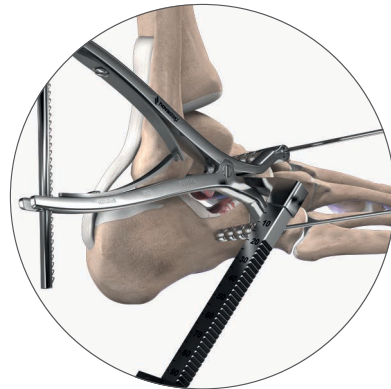

# Surgical Technique

**Other targeting guide positioning example:** When the subtalar joint surface is prepared, remove the open arms distractor. Assemble the targeting guide. Position the tip of the targeting guide on the tarsal sinus. Slide the clamp on the targeting guide arm to position the Nexis® Ø 7 K-wire sleeve on the posterior aspect of the calcaneum, at the entry point level of the first K-wire.



## 3 - K-wires positioning with targeting guide and parallel wire guide

**3.1 -** Insert a Ø 2.2 lg 200 K-wire in the Nexis® Ø 7 K-wire sleeve through the calcaneus until it reaches the tip of the targeting guide.

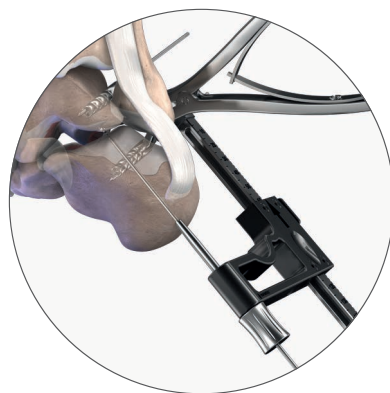

**3.2 -** Keep the K-wire in place and remove the Nexis® K-wire sleeve with the clamp, and the targeting guide arm.

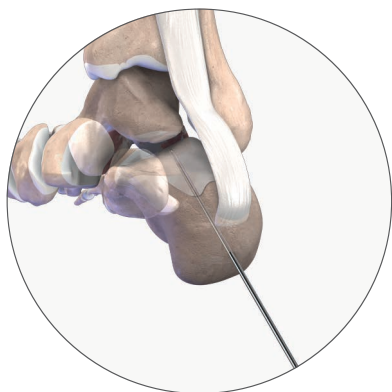

**3.3 -** Insert the Nexis® Ø 7 parallel wire guide on the K-wire.

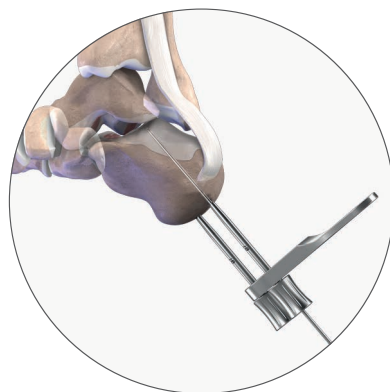

# Surgical Technique

**3.4** - Insert the second K-wire Ø 2.2 lg 200 in the Nexis® Ø 7 K-wire sleeve. Remove the parallel wire guide, letting the two K-wires in position.

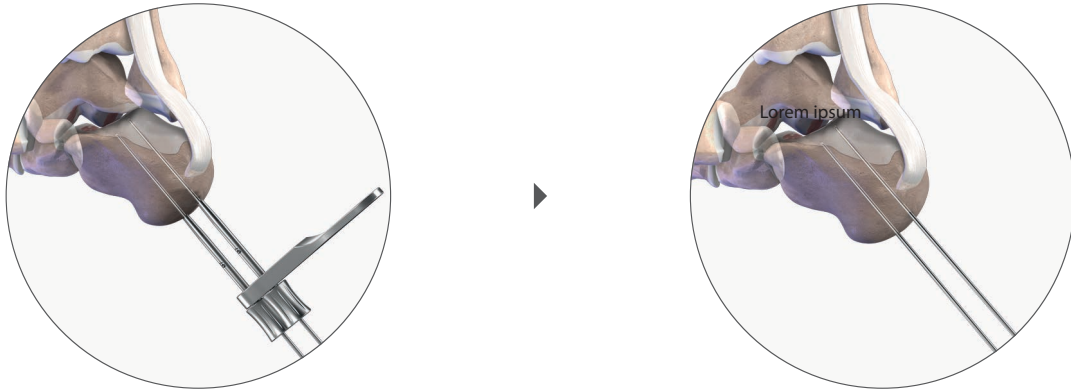

Remove the open arms distractor to reduce the subtalar joint. Insert both K-wires deeper into the talus until the appropriate depth with fluoroscopic guidance.

## 4 - Screws insertion

**Optional:** A double drill guide can be positioned over the K-wire.



### Option 1 - Pre-drill

*Pre-drilling is recommended in the presence of dense cortical bone.*

Nexis® cannulated drill bit Ø 4.8 is used to prepare the insertion of the screw. Use the drill bit over the K-wire until the appropriate depth. Screw length can be read directly off of the graduated drill bit.

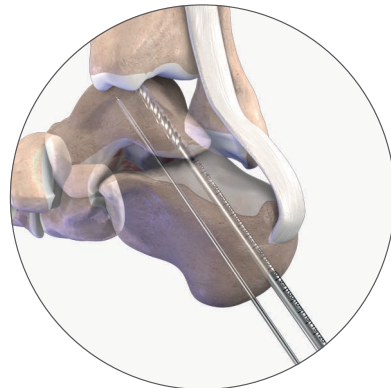

**Optional:** Nexis® Ø 6 countersink can be used to prepare the location of the screw head.



# Surgical Technique

Use the T25 large AO screwdriver tip over the K-wire to insert Nexis® Ø 7 screw manually or connected to the power driver that can be connected to our adaptor.

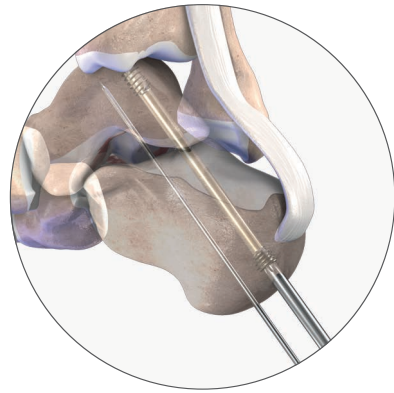

## Option 2 - Screw insertion without pre-drilling

Assess the appropriate screw length with the graduated Nexis® ruler.

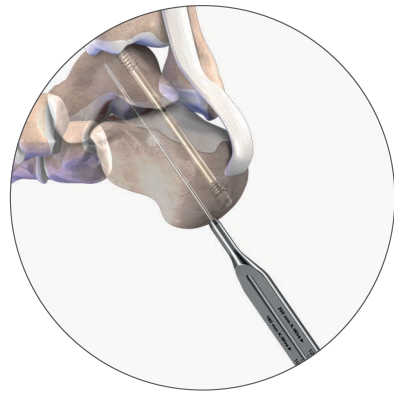

Use the T25 large AO screwdriver tip over the K-wire to insert Nexis® Ø 7 screw manually or connected to the power driver.

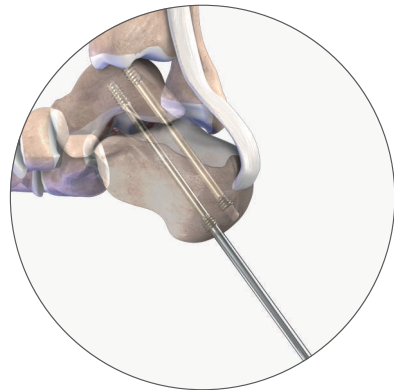

Confirm the placement and length of the screws under fluoroscopy and stability of the construct. Remove the K-wires before closing and dressing.





# References - Nexis® Screws Ø 5 / Ø 7 mm

## Implants

### Nexis® compressive screws



Length	Ø 5	Ø 7 short thread (16 mm)	Ø 7 long thread (32 mm) - optional
30	SC060030	-	-
32	SC060032	-	-
34	SC060034	-	-
36	SC060036	-	-
38	SC060038	-	-
40	SC060040	SC070040	SC080040
42	SC060042	-	-
44	SC060044	-	-
45	-	SC070045	SC080045
46	SC060046	-	-
48	SC060048	-	-
50	SC060050	SC070050	SC080050
55	SC060055	SC070055	SC080055
60	SC060060	SC070060	SC080060
65	SC060065	SC070065	SC080065
70	SC060070	SC070070	SC080070
75	SC060075	SC070075	SC080075
80	SC060080	SC070080	SC080080
85	SC060085	SC070085	SC080085
90	SC060090	SC070090	SC080090
95	SC060095	SC070095	SC080095
100	SC060100	SC070100	SC080100
105	-	SC070105	SC080105
110	-	SC070110	SC080110
115	-	SC070115	SC080115
120	-	SC070120	SC080120

## Instruments



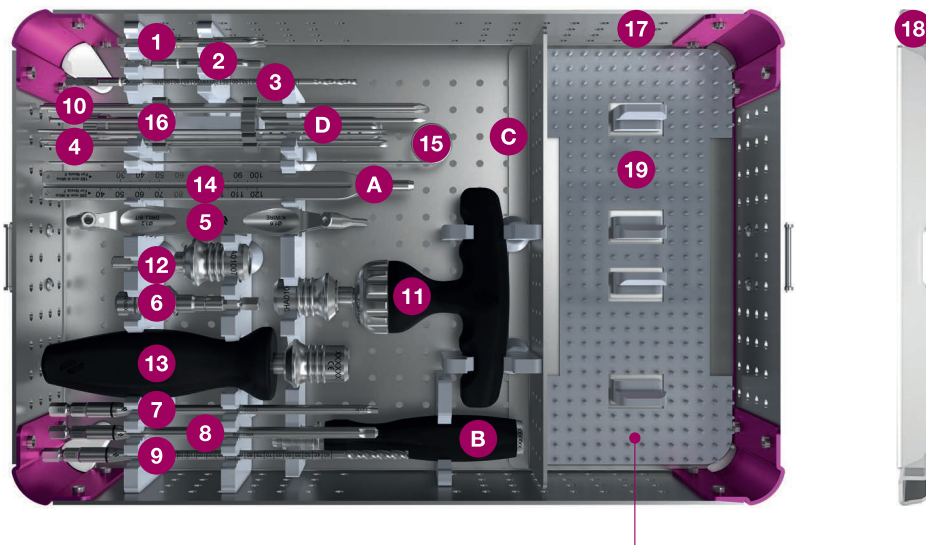



### Nexis® Ø 5 / Ø 7 set



Optional modules p.18, 19 & 20



# References - Nexis® Screws Ø 5 / Ø 7 mm

## Nexis® Ø 5 mm instrumentation

Number	Ref	Description	
1	XSD05001	T20 AO screwdriver tip	
1	XSD05002	Solid T20 AO screwdriver tip	
2	XRE01008	Countersink Ø 4.9	
3	XDB01009	Cannulated drill bit Ø 3.2	
4	-	K-wire Ø 1.6 lg 180 TR / RD <sup>(1)</sup>	
5	XDG01015	Double drill guide for screw Ø 5	
6	XHA01005	Adaptator 1/4" Hex Large AO - AO	





<sup>(1)</sup>K-wire supplied separately - Medetechnik® K-wire (33-T10-R-16-180) or Novastep® K-wire (CKW01004) are available depending on your market.

## Nexis® Ø 7 mm instrumentation

Number	Ref	Description	
7	XSD06003	T25 large AO screwdriver tip	
7	XSD06002	Solid T25 large AO screwdriver tip	
8	XRE01009	Countersink Ø 6	
9	XDB01010	Cannulated drill bit Ø 4.8	
10	-	K-wires Ø 2.2 lg 200 TR / RD <sup>(2)</sup>	
5	XDG01016	Double drill guide for screw Ø 7	
12	XHA01006	Adaptator AO - Large AO 1/4" Hex	

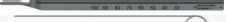
<sup>(2)</sup>K-wire supplied separately - Medetechnik® K-wire (33-T10-R-22-200) or Novastep® K-wire (CKW01005) are available depending on your market.

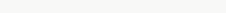
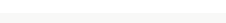
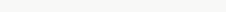
## Universal instrumentation

Number	Ref	Description	
11	XHA01004	Large AO T handle ratchet	
13	XHA01003	Large AO straight handle	
14	XGA01007	Ruler Lg 180/200	
15	XKW01003	Cleaning pin Ø 1.6	
16	ACC1008P0004	K-wires holder	
17	ACC1008P0001	Tray	
18	ACC1008P0002	Lid	
19	ACC1008P0003	Silicone mat	

## Optional instruments

Ref	Description	
XFP01008	Open arms distractor	
SKW05003 <sup>(3)</sup>	Threaded K-wire Ø 1.6 lg 140 TR-RD sterile	
SKW05004 <sup>(3)</sup>	Threaded K-wire Ø 2.5 lg 140 TR-RD sterile	

<sup>(3)</sup>Threaded K-wire supplied separately

The Nexis® Ø 5 / Ø 7 set can be completed with a :

- Nexis® Ø 4 module, and/or 15-18-20-25 ARCAD compressive staples module.
- Nexis® targeting guide

# References - Rearfoot Targeting Guide

## Nexis® Ø 5 / Ø 7 mm targeting guide module

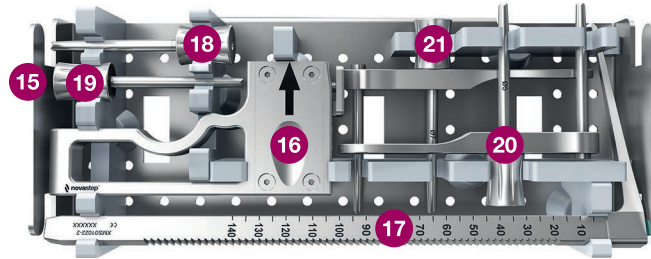

Number	Ref	Description
15	ACC1012P1003	Targeting guide module
16	XMS01022-1	Targeting guide clamp
17	XMS01022-2	Targeting guide arm
18	XMS01022-3	Nexis® Ø 5 - K-wire sleeve
19	XMS01022-4	Nexis® Ø 7 - K-wire sleeve
20	XMS01023	Nexis® Ø 5 - Parallel wire guide
21	XMS01024	Nexis® Ø 7 - Parallel wire guide

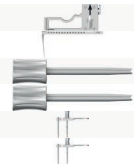

## Nexis® Ø 5 / Ø 7 mm targeting guide set

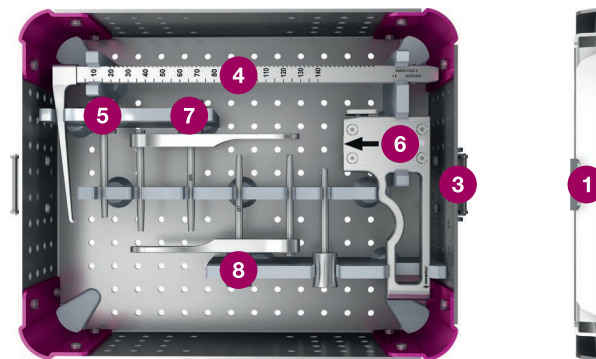

Number	Ref	Description
1	ACC1012P0001	Targeting guide tray
2	ACC1012P0002	Targeting guide lid
3	XMS01022-1	Targeting guide arm
4	XMS01022-2	Targeting guide clamp
5	XMS01022-3	Nexis® Ø 5 - K-wire sleeve
6	XMS01022-4	Nexis® Ø 7 - K-wire sleeve
7	XMS01023	Nexis® Ø 5 - Parallel wire guide
8	XMS01024	Nexis® Ø 7 - Parallel wire guide

# References - Nexis® Screw Ø 4 mm

## Implants

### Nexis® compressive screw

Length	Ø 4
18	SC050018
20	SC050020
22	SC050022
24	SC050024
26	SC050026
28	SC050028
30	SC050030
32	SC050032
34	SC050034
36	SC050036
38	SC050038
40	SC050040
42	SC050042
44	SC050044
46	SC050046
48	SC050048
50	SC050050
55	SC050055
60	SC050060

## Instruments

### Nexis® Ø 4 mm module

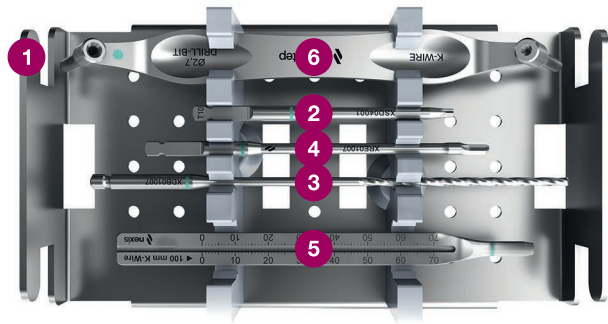

Number	Ref	Description
1	ACC1002P0004	Module
2	XSD04001	T10 AO screwdriver tip
3	XDB01007	Cannulated drill bit Ø 2.7
4	XRE01007	Nexis® / PECA®-C - Countersink Ø 3.7
5	XGA01004	Ruler Lg 100
6	XDG01009	Double drill guide for screw Ø 4
C	XKW01002	Cleaning pin Ø 1.4 <sup>(1)</sup>
D	XMS01001	K-wire tube <sup>(1)</sup>
D	-	K-wire Ø 1.4 lg 100 TR / RD <sup>(2)</sup>
A	XGA01002	Depth gauge <sup>(1)</sup>
B	XHA01001	AO handle <sup>(1)</sup>



<sup>(1)</sup>Instruments included in Nexis® Ø 5 / Ø 7 set.

<sup>(2)</sup>K-wire supplied separately - Medetechnik® K-wire (33-T10-R-14-100) or Novastep® K-wire (CKW01002) are available depending on your market.

# References - Arcad® Compressive Staples

## Implants



### Arcad® compressive staples 15-18-20-25

Ref	Description	Bridge width	Leg length	Wire dimensions
CS031212	Arcad® compressive staples 15-12-12	15 mm	12-12 mm	1,3 x 1,8 mm
CS031414	Arcad® compressive staples 15-14-14	15 mm	14-14 mm	1,3 x 1,8 mm
CS041212	Arcad® compressive staples 18-12-12	18 mm	12-12 mm	1,3 x 1,8 mm
CS041414	Arcad® compressive staples 18-14-14	18 mm	14-14 mm	1,3 x 1,8 mm
CS041416	Arcad® compressive staples 18-14-16	18 mm	14-16 mm	1,3 x 1,8 mm
CS041618	Arcad® compressive staples 18-16-18	18 mm	16-18 mm	1,3 x 1,8 mm
CS041818	Arcad® compressive staples 18-18-18	18 mm	18-18 mm	1,3 x 1,8 mm
CS051818	Arcad® compressive staples 20-18-18	20 mm	18-18 mm	2,5 x 1,6 mm
CS062020	Arcad® compressive staples 25-20-20	25 mm	20-20 mm	2,5 x 1,6 mm

## Instruments

### Arcad® 15-18-20-25 module

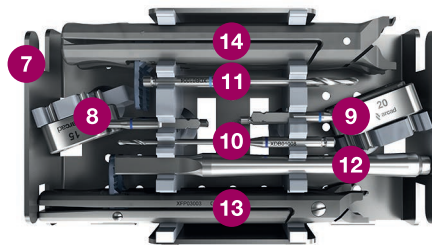

Number	Ref	Description	
7	ACC1005P0007	Module	
8	XDG01003	Arcad® 15 - drill guide	
8	XDG01004	Arcad® 18 - drill guide	
9	XDG01005	Arcad® 20 - drill guide	
9	XDG01006	Arcad® 25 - drill guide	
10	XPP01001	Positioning pin Ø 2	
11	XPP01002	Positioning pin Ø 3	
12	XMS01002	Impactor	
10	XDB01008	Drill bit Ø 2	
11	XDB01004	Drill bit Ø 3	
13	XFP03003	Arcad® 15 - forceps	
13	XFP03004	Arcad® 18 - forceps	
14	XFP03005	Arcad® 20 - forceps	
14	XFP03006	Arcad® 25 - forceps	
A	XGA01002	Depth gauge <sup>(1)</sup>	
B	XHA01001	AO handle <sup>(1)</sup>	

<sup>(1)</sup>Instruments included in Nexis® Ø 5 / Ø 7 set.





# nexis<sup>®</sup>

Cannulated Screws

**Please note:**

Carefully read the enclosed Instructions For Use (IFU) and all packaging label information. Devices: Implants: Class IIb-CE1639 / Instruments: Class I / Class Ir-CE1639 / Class IIa-CE1639.

**Novastep:**

2, Allée Jacques Frimot - 35000 RENNES - France  
Tel. : + 33 (0) 2 99 33 86 50 / Fax : + 33 (0) 9 70 29 18 95  
[contact@novastep-ortho.com](mailto:contact@novastep-ortho.com) / [www.int.novastep.life](http://www.int.novastep.life)

Reference: Nex-REAR-ST-Ed6-07-24-EN