



SURGICAL  
TECHNIQUE

enovis™

# AIRLOCK®

FOOT PLATING SYSTEM

PLATING SYSTEM

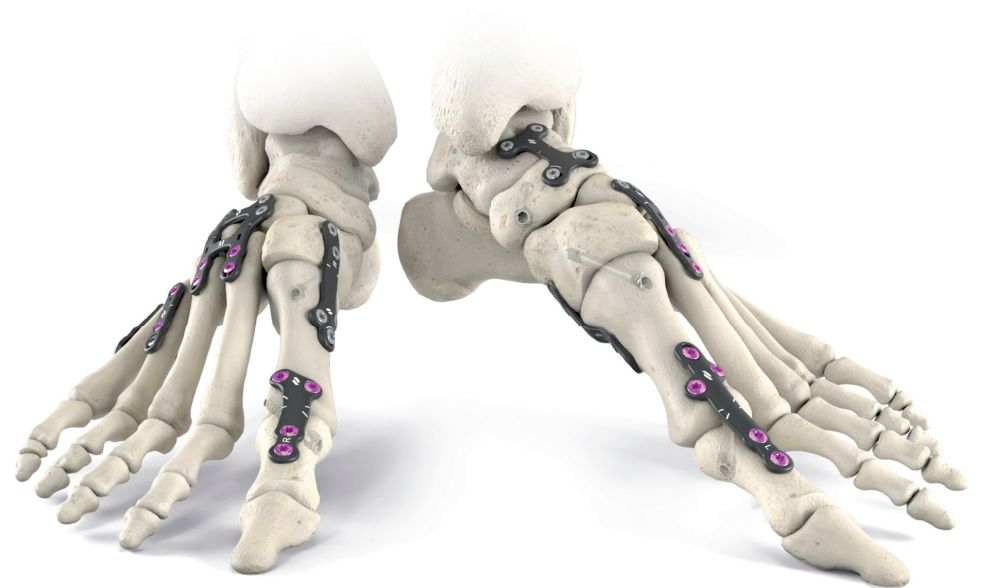

INDICATIONS & CONTRAINDICATIONS .....	3
DESIGN FEATURES .....	4
SURGICAL TECHNIQUE .....	20
ORDERING INFORMATION .....	36

Novastep® S.A.S is a manufacturer of orthopedic implants and does not practice medicine. This surgical technique was prepared in conjunction with licensed health care professionals. The treating surgeon is responsible for determining the appropriate treatment, technique(s), and product(s) for each individual patient.

See package insert for complete list of potential adverse effects, contraindications, warnings and precautions.

A workshop training is recommended prior to performing your first surgery. All non-sterile devices must be cleaned and sterilized before use.

Multi-component instruments must be disassembled for cleaning. Please refer to the corresponding assembly/disassembly instructions, if applicable. Please remember that the compatibility of different product systems has not been tested unless specified otherwise in the product labeling.

The surgeon must discuss all relevant risks including the finite lifetime of the device with the patient.

Some implants / instruments are not available in all territories. For more information, please contact your local sales representative.

## INDICATIONS

The osteosynthesis screw-plate systems are indicated for arthritis (Hallux Rigidus, Osteoarthritis), Hallux valgus and other bone alignment defaults (Hallux Varus, Flatfoot, Cavus foot).

**NOTE:** Detailed information on each medical device is provided in the instructions for use. Refer to the instructions for use for a complete list of side effects, warnings, precautions, and directions for use.

## CONTRAINDICATIONS

- Severe muscular, neurological or vascular deficiency in the extremity concerned.
- Bone destruction or poor bone quality likely to impair implant stability.
- Hypersensitivity to vanadium and/or aluminium.

## EXAMPLES OF USE

### FOREFOOT

- First MTP joint arthrodesis (Hallux-valgus – Hallux Rigidus)
- Revision of first MTP joint arthrodesis
- Opening or closing Basal osteotomy (Hallux Valgus)

### MIDFOOT/REARFOOT

- Talo-navicular arthrodesis
- Lapidus arthrodesis
- Partial or complete Lisfranc arthrodesis
- Calcaneo-cuboid arthrodesis
- Evans and Cotton osteotomies
- Malerba and Dwyer osteotomies
- Tarsectomy



The Airlock® plating system includes a range of osteosynthesis plates for the forefoot, midfoot and rearfoot, made of TA6V ELI Titanium alloy. It combines a low profile plate design dedicated to each indication, a compression hole, and a monoaxial and polyaxial screw system to ensure a stable and rigid fixation. The Presslock® technology provides a locking compression hole that ensures a stable construct.

**LOW PROFILE DESIGN > PLATES THICKNESS OPTIMIZED ACCORDING TO THE INDICATIONS TO LIMIT SUBCUTANEOUS DISCOMFORT.**

### 1. STANDARD COMPRESSION HOLE

- Accommodates with  $\varnothing 3$  non-locking screws.
- Delivers 1.5mm of additional compression.
- Corresponds to areas with high bone density.



### 2. THREADED HOLES

- For locking or non-locking screws.

### 3. VISUAL ALIGNMENT GUIDE FOR ARTHRODESIS LINE

- Precise positioning of the plate in relation to the arthrodesis line.

### 4. VISUAL ALIGNMENT GUIDE FOR COMPRESSIVE PLANTAR SCREW

- Helps the MTP plate positioning in relation to the interfragmentary screw.

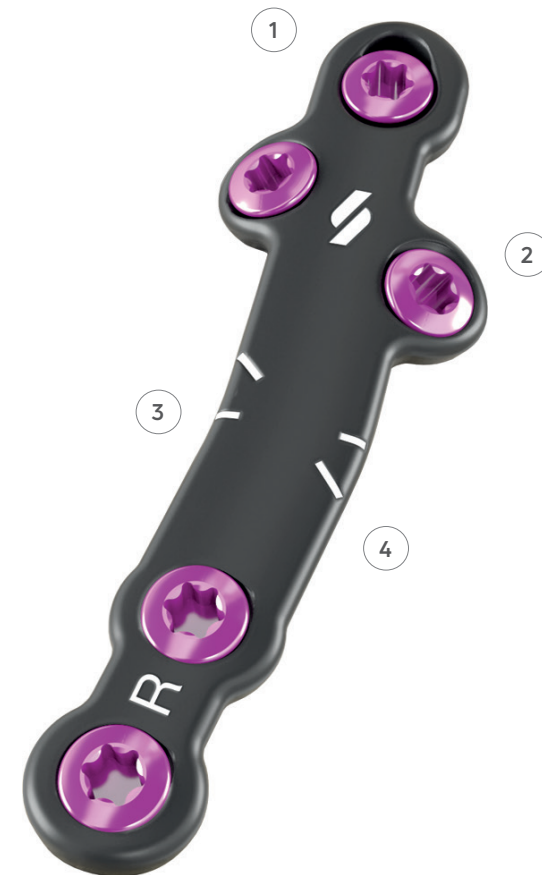

## PRESSLOCK® INNOVATION - PATENTED

Locking compression hole for Ø3.5mm locking screw. Allows for an additional 1.5 mm compression before locking into a threaded hole, providing strength and stable fixation.

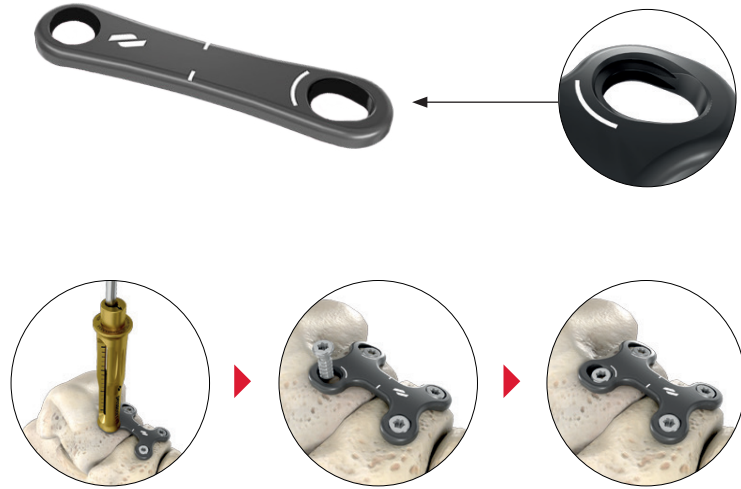

PRESSLOCK® 3 STEP PROCEDURE: DRILL, COMPRESS & LOCK

AVAILABLE ON



FUSION



LAPIDUS



PLANTAR  
LAPIDUS

## AIRLOCK® RANGE

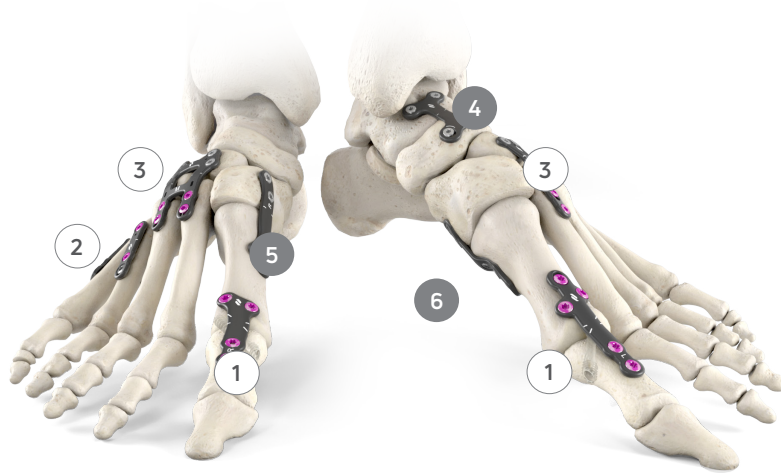

## MTP

①

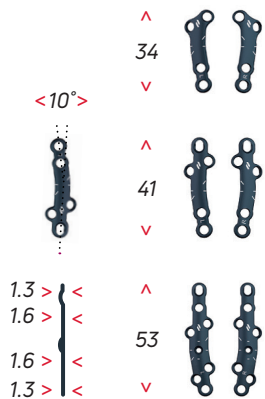

### SHORT

- Thickness: 1.3mm

### MEDIUM

- Thickness: 1.3mm
- Compression hole

### LONG

- Thickness: varies from 1.3mm to 1.6mm along the joint line
- Compression hole
- Central port hole allow for graft insertion and snap-off screw

## UTILITY

②

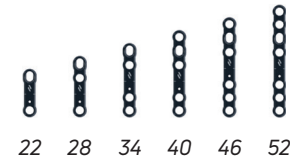

### 6 VERSIONS

- 2, 3, 4, 5, 6 & 7 holes
- Thickness: 1.5mm
- Compression hole

## LISFRANC

③



SHORT



LONG

### T PLATES H PLATES

- Thickness: 1.5mm
- Compression hole



S



M



L

## MT BASE



L

R



30

30

31

32

### CLOSING WEDGE

- 0mm wedge

### OPENING WEDGE

- 3, 4 & 5mm wedge
- Thickness: 1mm

## WITH PRESSLOCK®

### FUSION

4



#### STRAIGHT PLATES H PLATES

- Thickness: 1.6 mm
- Presslock® compression locking hole

### MONOAXIAL & POLYAXIAL SYSTEM

#### Ø3 & Ø3.5mm LOCKING & NON LOCKING SCREWS



- Polyaxial non locking screws
- Monoaxial locking screws
- Conical head
- Self-tapping
- Self-retaining driver / screw interface

### LAPIDUS

5



#### SHORT PLATES LONG PLATES

- \*Thickness: 1.3mm
- \*Thickness increases to 1.6 mm in the Presslock® hole area
- Presslock® compression locking hole

### PLANTAR LAPIDUS

6

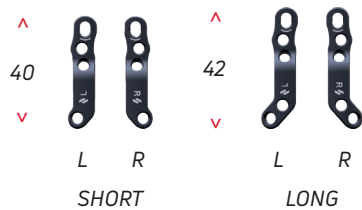

#### SHORT PLATES LONG PLATES

- \*Thickness\*: 1.6mm
- Presslock® compression locking hole

## COMPREHENSIVE MODULAR PLATFORM

Used together or separately, these instrument trays allow a comprehensive approach to the various indications of foot surgery.



AIRLOCK® TRAY

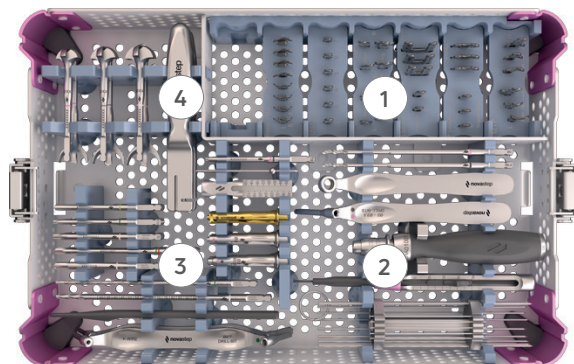

DISTRACTOR & COMPRESSOR TRAY

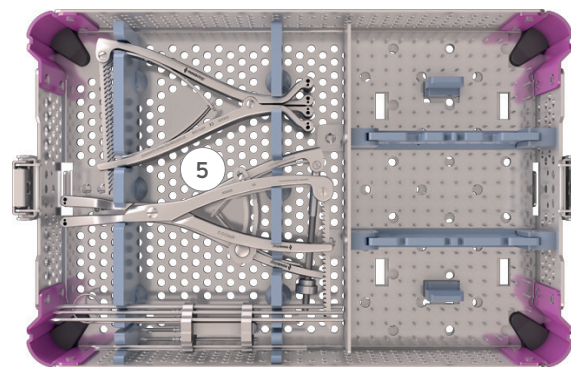

**1. TRIAL PLATES**

**2. AIRLOCK® INSTRUMENTATION**

Windowed drill guide: direct reading of the required screw length

**3. NEXIS® & PECA®-C INSTRUMENTATION**

**4. BENDERS & REAMERS**

**5. DISTRACTORS & COMPRESSOR**



OPEN ARM  
DISTRACTOR



CLOSED ARM  
DISTRACTOR



OPENING WEDGE  
DISTRACTOR



COMPRESSOR

## AIRLOCK® SET & OPTIMIZED INSTRUMENTATION

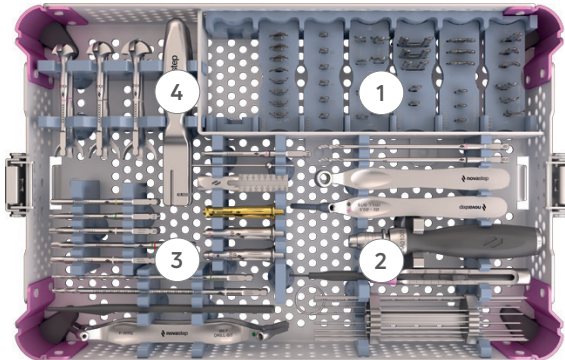

### 1. TRIAL PLATES

### 2. AIRLOCK® INSTRUMENTATION

Windowed drill guide: direct reading of the required screw length

### 3. NEXIS® & PECA®-C INSTRUMENTATION

### 4. BENDERS & REAMERS

## WINDOWED DRILL GUIDES

Direct reading of the required screw length.



### DRILL GUIDES FOR UNIVERSAL HOLE

- Locking drill guide for Ø2mm & 2.5mm drill bits.
- Polyaxial drill guide for Ø2mm & 2.5mm drill bits.



### DRILL GUIDES FOR STANDARD COMPRESSION HOLE

- Compression drill guide for Ø2mm drill bits



### DRILL GUIDES FOR PRESSLOCK® COMPRESSION LOCKING HOLE

- Presslock® gold drill guide for Ø2 & 2.5mm drill bits

## SCREW FIXATION PROCESS

The Airlock® Ø3 and Ø3.5mm locking and non-locking screws may be used in all Airlock® plate fixation holes, but:

- Standard compression holes accommodate Ø3mm non-locking screws only;
- Presslock® compression locking holes accommodate Ø3.5mm locking screws only.

Screw insertion follows an intuitive three-step procedure: drilling, measurement and screw insertion. Each instrument is conveniently organized and color-coded.

## COLOR CODE

### AIRLOCK® SCREWS:

- Instrumentation for Ø3mm screws
- Instrumentation for Ø3.5mm screws

### COMPRESSIVE SCREWS

- Instrumentation for Nexis® Ø4mm screws
- Instrumentation for Nexis® Ø5mm screws
- Instrumentation for PECA®-C Ø4mm screws

**TIP:** To position a plate, thread 2 locking drill guides in 2 universal holes. Position the plate as desired using the drill guides to manipulate it. Drill the first screw hole with the drill bit of the correct diameter. Leave the drill bit inside to keep the position and drill the second screw hole with a second drill bit. Determine the appropriate screw length by reading the length directly off the windowed drill guide where it matches the calibrated etching on the drill bit or using the depth gauge. Insert the selected screw. Withdraw the drill guide and insert the screw. Determine the screw length for the other hole before inserting the screw.

In case of uncertainty, screw lengths may be verified by means of the screw length indicator.



Ø2mm DRILL BIT



Ø2.5mm DRILL BIT - OPTIONAL

## UNIVERSAL HOLE

First, fixate the side of the plate that is opposite to the standard compression hole or Presslock® hole, with or without locking. Thread the locking drill guide in one of the threaded holes or position the polyaxial drill guide and drill with the appropriate diameter drill bit. Determine the appropriate screw length by reading the measurement directly off the windowed drill guide or using the depth gauge. Insert the selected screw with the self-retaining screwdriver tip.

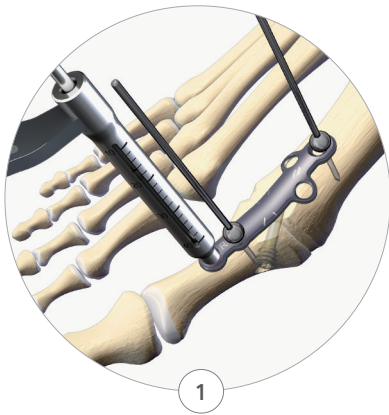

**DRILL**

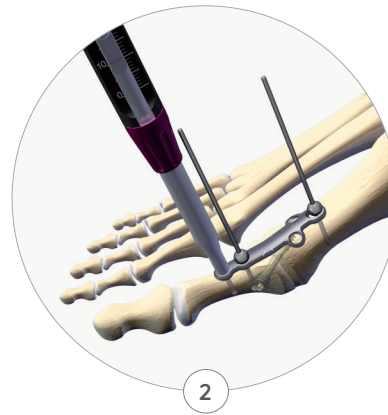

**MEASURE**

Read directly off the windowed drill guide or use the depth gauge.

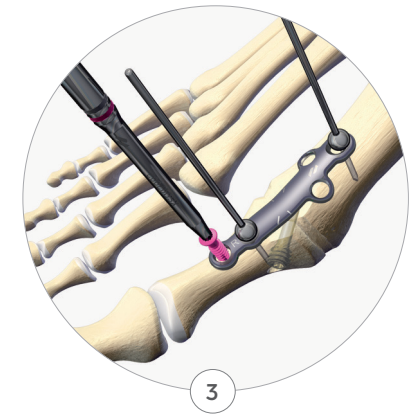

**INSERT**

## INSTRUMENTATION GUIDELINES

### LOCKING SCREWS

### NON LOCKING SCREWS

3mm  
DIAMETER



3.5mm  
DIAMETER



\*Ø2.5 DRILL BIT - OPTIONAL

## STANDARD COMPRESSION HOLE

Start plate fixation opposite the side of the compression hole. The oblong drill guide allows both neutral or compression screw fixation, giving 1.5 mm of additional compression. If no compression is required, use the drill guide in its neutral position.

**NOTE:** Compression holes only accommodate the  $\varnothing 3$ mm non-locking screws.

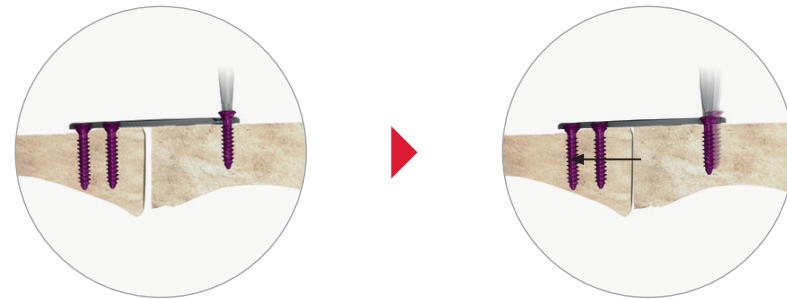

*COMPRESSION SLOT GENERATES MECHANICAL COMPRESSION BETWEEN THE TWO BONE SEGMENTS.*

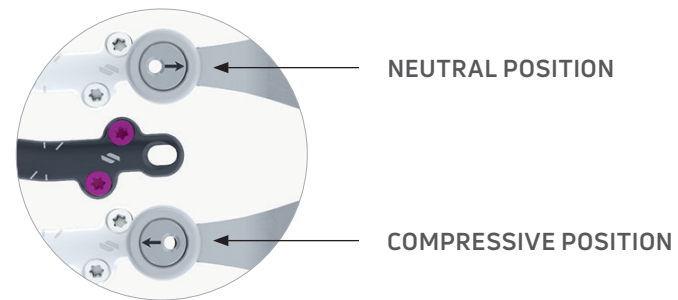

## INSTRUMENTATION GUIDELINES

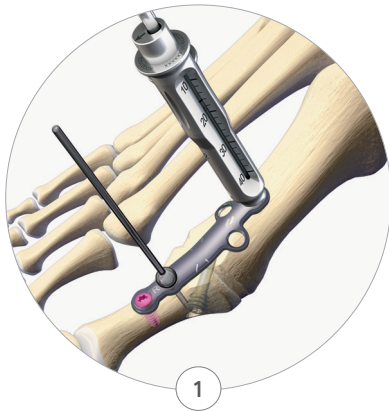

### DRILL

Ø3mm non-locking screws only



### MEASURE

Directly read off the windowed drill guide or use of the depth gauge

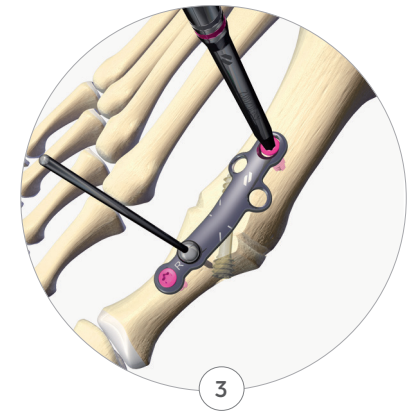

### INSERT

Screwdriver tip



## PRESSLOCK® COMPRESSION LOCKING HOLE

Start plate fixation opposite the side of the Presslock® compression hole. The Presslock® drill guide allows neutral or compression screw fixation, giving up to 1.5 mm of compression.

To achieve compression locking, position the Presslock® gold drill guide line the Presslock® hole.

If no compression is required, use the Presslock® drill guide in its neutral position.

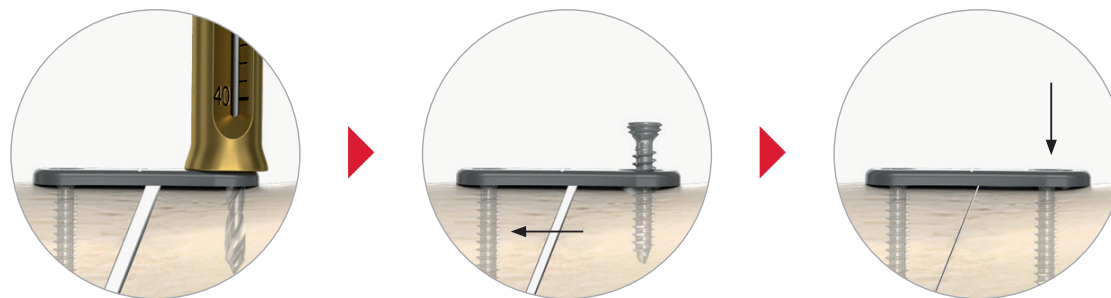

*PRESSLOCK® SLOT GENERATES MECHANICAL COMPRESSION BETWEEN TWO BONE SEGMENTS, BEFORE SUBSEQUENT LOCKING IN THE THREADED PART OF THE SLOT.*

**NOTE:** Presslock® holes, available on the universal Fusion and on the Lapidus and Plantar Lapidus plates, only accommodate Ø3.5mm locking screws. Presslock® holes are easily identified by their oblong shape and engraved circular arc.

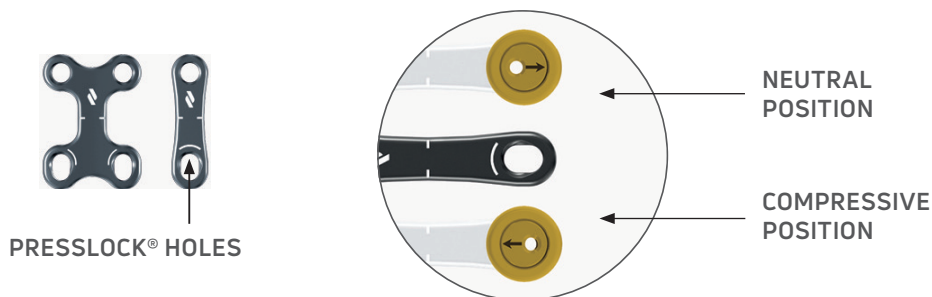

## INSTRUMENTATION GUIDELINES

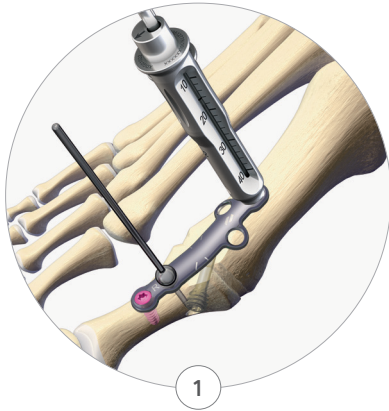

### DRILL

Ø3.5mm locking screws only

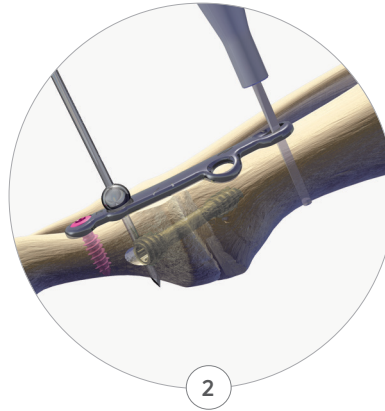

### MEASURE

Read directly off the windowed drill guide or use the depth gauge.

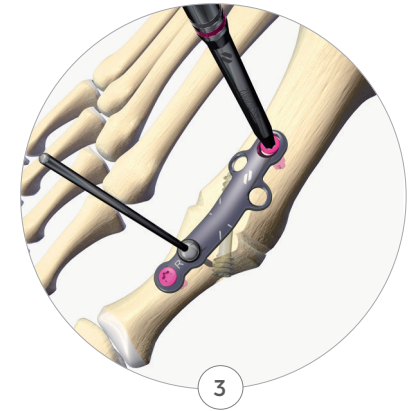

### INSERT

Screwdriver tip



\* Ø2.5 DRILL BIT - OPTIONAL



### CONCAVE / CONVEX REAMERS

Specific instrumentation, with 3 Concave / Convex reamer sizes (Ø18mm, Ø20mm, Ø22mm) facilitate precise joint surface contouring and positioning. Always be sure to use the concave and convex reamers of the same diameter.

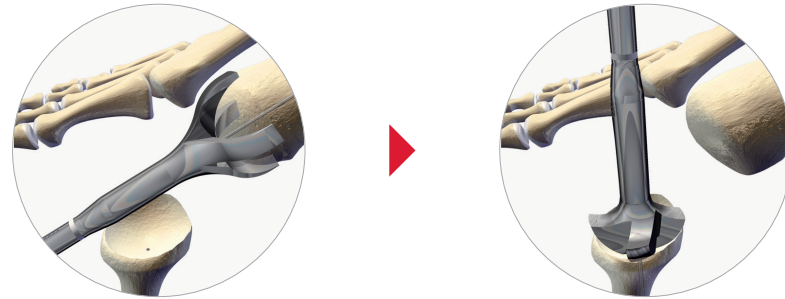

### PLATE BENDER PROCEDURES

Most of the time, bending is not necessary. In some rare cases plate benders may be required. The following guidelines must be considered:

- Bend the plate only in one direction.
- Never reverse-bend a plate.
- Always ensure that the threaded holes of a plate are not compromised during bending.
- It is not recommended to bend at the plate extremities.

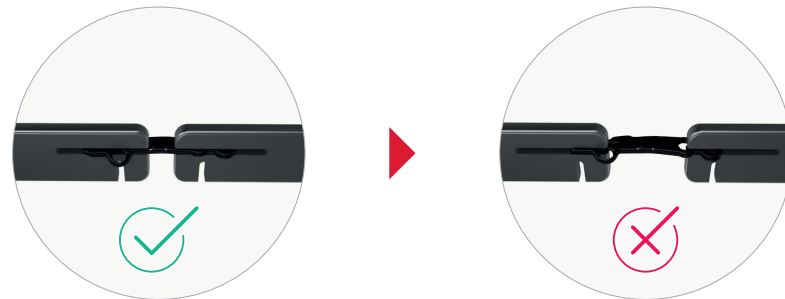

**NOTE:** The MTP Long and Plantar Lapidus plates must not be bent in order to avoid damaging the central hole.

## DISTRACTOR & COMPRESSOR SET

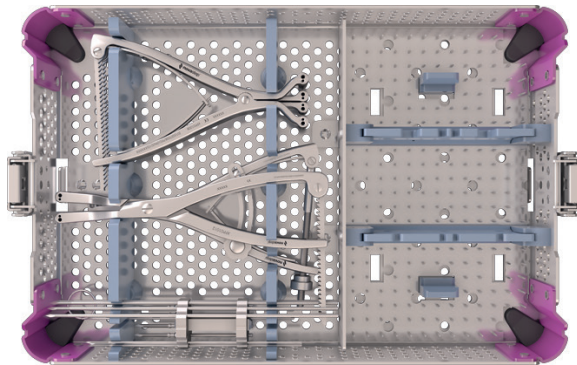

### 5. DISTRACTORS & COMPRESSOR



OPEN ARM  
DISTRACTOR



CLOSED ARM  
DISTRACTOR



OPENING WEDGE  
DISTRACTOR



COMPRESSIVE  
DISTRACTOR

## OPENING WEDGE DISTRACTOR



### 1. ANATOMICAL WEDGE-SHAPED OPENING AIRLOCK® INSTRUMENTATION

Made possible by the ball-and-socket joint on dedicated threaded k-wires

### 2. OPENING WEDGE THREADED K-WIRES BENDERS & REAMERS

Allow a stable opening and a distraction close to the bone

### 3. EASY-TO-MEASURE OPENING

After k-wires insertion adjust the initial position to 0. The sliding graduated ruler allows 0-12 mm sizing increments

### 4. EASY AND PRECISE ADJUSTMENT OF THE OPENING

Fixed by a screwed wheel.

## EXAMPLE OF USE OF THE OPENING WEDGE DISTRACTOR ON AN EVANS OSTEOTOMY

1. PLACEMENT OF THE WIRES AND DISTRACTOR AT THE BONE CUT



2. SETTING THE INITIAL POSITION TO 0 MM ON THE RULER BEFORE DISTRACTION. Turn the dial (1) to allow the movement of the ruler (2).

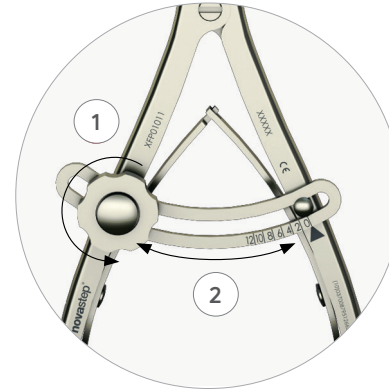

3. PERFORMING THE DISTRACTION WITH A WEDGE-SHAPED ANATOMICAL OPENING

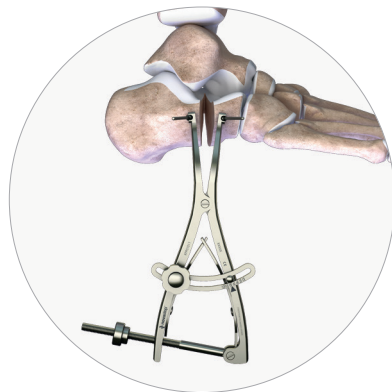

4. PLACEMENT OF A BONE GRAFT AND AN AIRLOCK® FUSION PLATE

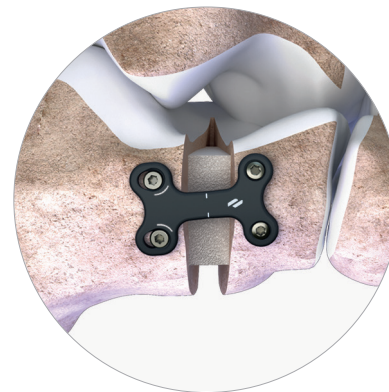

## 1. FIRST MTP JOINT ARTHRODESIS

### MTP PLATING SYSTEM BENEFITS

> 3 sizes available in Left & Right options: **SHORT, MEDIUM & LONG**



> **LOW-PROFILE PLATE DESIGN (1.3MM THICKNESS) REDUCES SOFT TISSUE IRRITATION AROUND THE MTP JOINT**

For improved strength, the MTP long plate increases in thickness from 1.3 mm to 1.6 mm along the joint line

> **STANDARD COMPRESSION SLOT** for optimal compression

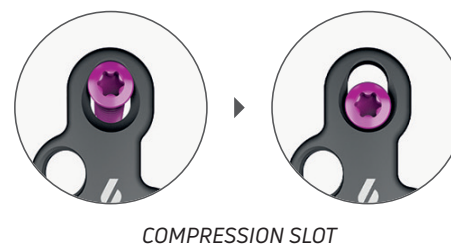

> **THREADED HOLES** for Ø3mm & Ø3.5mm locking or non-locking screws

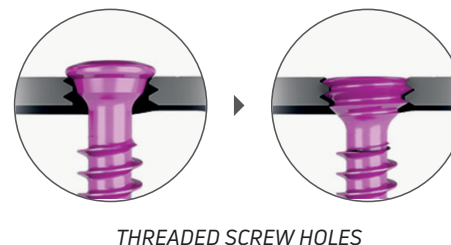

> Anatomic plates designed with 0° dorsiflexion, delivering 15° of metatarsophalangeal dorsiflexion while preserving 10° anatomical phalangeal valgus



## LONG MTP PLATE VISUAL ALIGNMENT GUIDE

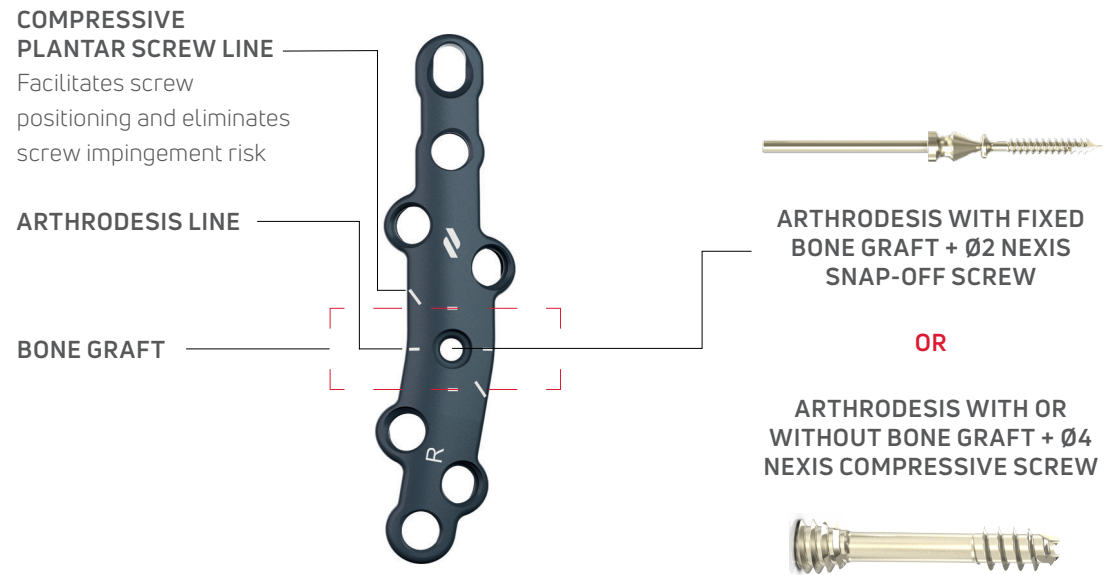

### 1.1 INCISION & EXPOSURE

A medial incision is most commonly used for First MTP joint exposure (**FIGURE 1**). A dorsal approach could be also considered. It is recommended to identify and to protect the dorsal collateral nerve to avoid any risk of damage during opening or closing steps. An exostectomy is performed with an oscillating saw and a large circumferential arthrolysis is performed to expose the entire joint area. Osteophytes are completely resected.



FIGURE 1

## 1.2 METATARSAL & PHALANGEAL PREPARATION

Care should be taken to protect skin and soft tissue during the joint surface preparation. Two options may be considered: Flat Cut Technique or Cup & Cone Technique.

- The Cup & Cone Technique allows an easier and more precise adjustment that preserves bone stock, but requires more exposure. Adapt the cut with consideration for first ray length and overall bone quality (cancellous and sclerotic bones).
- In case of shortening, flat cuts are recommended.
- In case of poor quality bones or osteoporotic bones, gouge forceps preparation is preferred.
- In case of sclerotic bone, the Cup & Cone Technique is recommended. To facilitate fusion, weaken the counteropposing surfaces with gouge forceps, oscillating saw or bone scraper prior to application of the Cup & Cone reamers.

Displace the phalanx plantarly, exposing the metatarsal head (it is recommended to start the metatarsal preparation first to enable proper exposure of the phalanx).

Using a power drill, place a Ø 1.6 mm K-Wire through the center of the metatarsal head and into the diaphysis of the metatarsal. Utilize the largest reamer size to start the metatarsal reaming process (**FIGURE 2**).

Reaming of the phalanx is performed in a similar fashion to the metatarsal head.

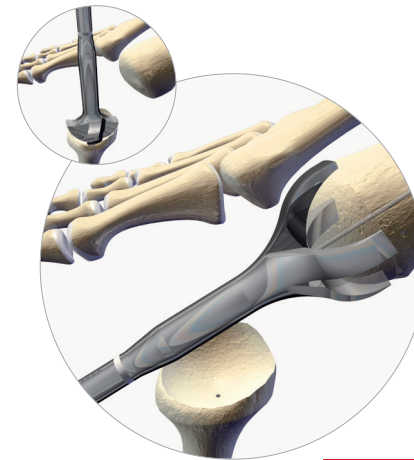

FIGURE 2



FIGURE 3

**NOTE:** Joint surface may be prepared by performing perforations with a drill bit or K-wire (**FIGURE 3**).

## 1.3 TEMPORARY FIXATION

Provisionally stabilize the joint by inserting a Ø1.6mm K-Wire from the dorsal medial aspect of the first metatarsal to the dorsal lateral cortex of the first phalanx (**FIGURE 4**).

Check the correct position (approximately 15° of dorsiflexion) using the support plate, located inside the lid of the instrument tray (**FIGURE 5**).

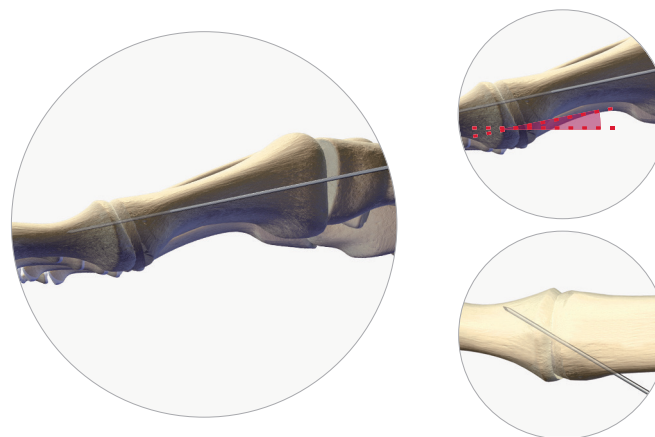

FIGURE 4

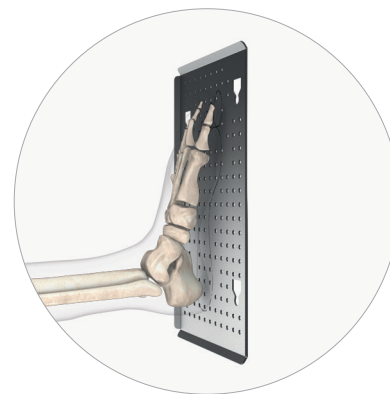

FIGURE 5

*MEDIAL / LATERAL ASPECT: DIFFERENCE BETWEEN THE SUPPORT PLATE AND THE PULP OF THE BIG TOE < 5 MM.*

## 1.4 PLANTAR SCREW INSERTION

Place the trial implant using the locking drill guide screwed in the proximal hole. Plantar screw guide marks on the surface of the trial implant depict the recommended orientation for insertion of the  $\varnothing 1.4$  K-Wire (approximately  $35^\circ$  relative to the metatarsal axis). Identify the appropriate plate reference according to the trial implants (**FIGURE 6**).

Determine screw length using the measuring gauge (**FIGURE 7**).

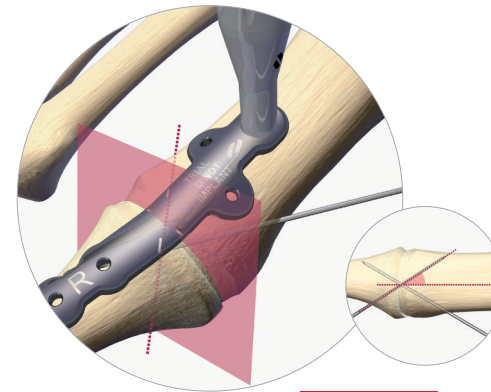

**FIGURE 6**

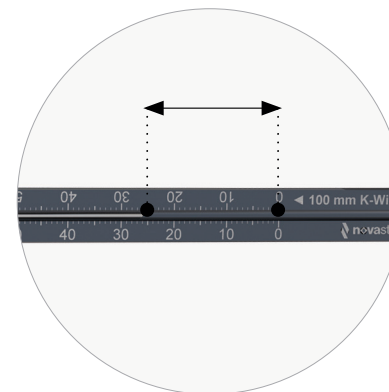

**FIGURE 7**

### OPTION 1 : SELF-DRILLING SCREW

Use the T10 screwdriver tip to insert the Ø4mm compressive screw manually (using a driver handle) or with a power tool. Check to ensure proper stability at the osteotomy site (**FIGURE 8**).

### OPTION 2 : PRE-DRILLING AND COUNTERSINK

Prepare bone housing using the dedicated Ø2.7mm drill bit and Ø3.7 countersinking reamer. Insert the screw with the T10 screwdriver tip. (**FIGURE 9**).

**NOTE:** Replace the Nexis® Ø4mm screw with the PECA® Compressive Ø4mm screw to allow maximization of cortical anchorage and preservation of soft tissues thanks to the bevelled head. In this case, be sure to use the associated instrumentation: the Exact-T®10 screwdriver tip and, if necessary, the PECA® 4 Ø3.2mm AO drill bit and the Nexis® / PECA® Ø3.7mm countersink.

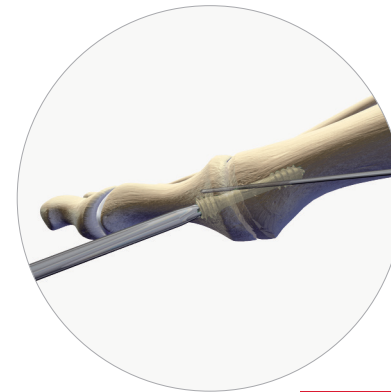

FIGURE 8

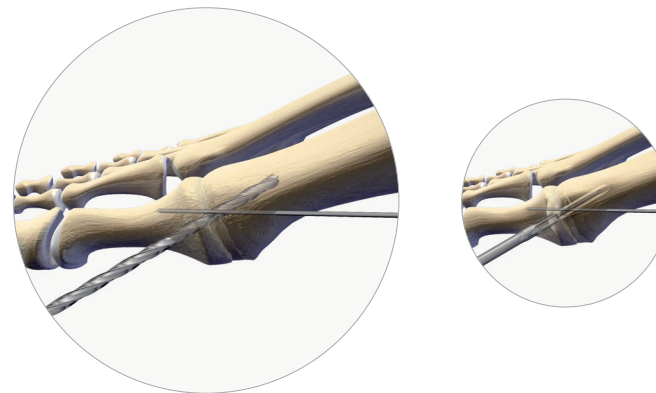

FIGURE 9

## 1.5 PLATE POSITIONING

### PLATE HOUSING PREPARATION

If necessary, flatten the dorsal surface using an oscillating saw or gouge forceps (**FIGURE 10**).

### PLATE POSITIONING

With the joint now stabilized, the plate should be placed over the joint and positioned according to patient's anatomy. When the proper orientation is determined, insert the spheric positioning pins to secure the plate over the bone as illustrated in **FIGURE 11**.

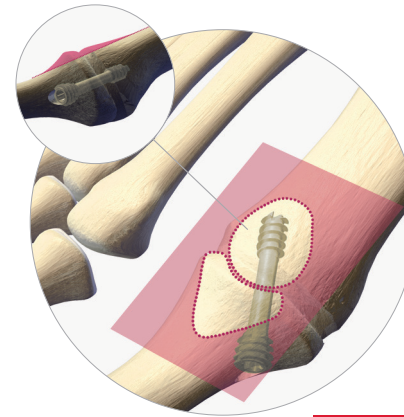

FIGURE 10



FIGURE 11

## DISTAL SCREW INSERTION

The steps for inserting Airlock® screws and the use of associated instruments are specified p 11 & 13.

Prepare the most distal screw hole using the drill bit Ø 2.0 mm and locking drill guide (for locking screws) or the polyaxial drill guide (for non-locking screws) (FIGURE 12).

Determine the appropriate screw length by directly reading off the windowed drill guide or using the depth gauge. Insert the selected screw (FIGURE 13).

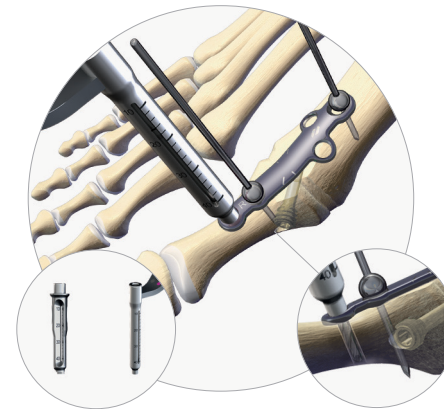

FIGURE 12

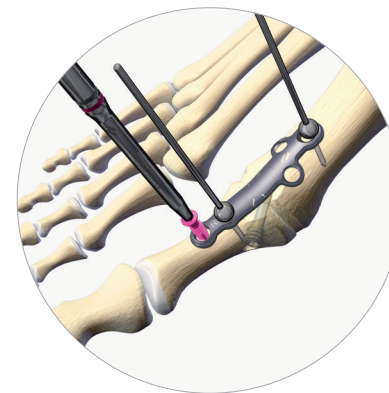

FIGURE 13

**NOTE:** It is recommended to first insert a non-locking screw prior to introducing locking screws to position the plate flush with respect to the cortical surface. It is also recommended to perform distal fixation prior to inserting the proximal screws and always prior to using the proximal compression hole.

## 1.6 PROXIMAL SCREW INSERTION

Using the compressive drill guide, drill the compression screw hole for non-locking screw (**FIGURE 14**).

Each proximal wire must be removed prior to compressing the joint.

If compression is not required, use the compressive drill guide in its neutral position (see p13). Determine the appropriate screw length and insert the screw until full compression is achieved. (**FIGURE 15**).

## 1.7 SCREW INSERTION

Insert the remaining screws and check the stability of the assembly (**FIGURE 16**).

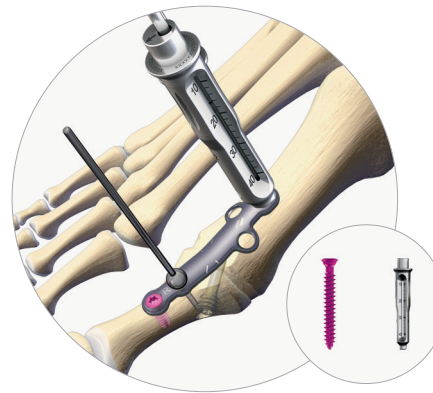

FIGURE 14

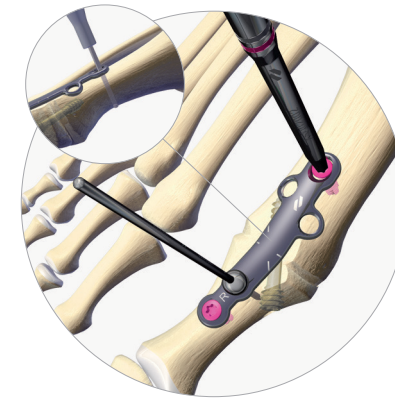

FIGURE 15

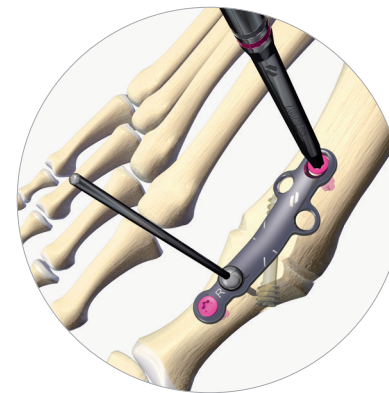

FIGURE 16

## 2. TALO-NAVICULAR ARTHRODESIS

### 2.1 INCISION & EXPOSURE

A dorsal incision is most commonly used for TN joint exposure. A medial incision can be made following the surgeon's preference.

Once the joint is exposed, position a closed arm distractor on the talus and navicular bones. Sterile threaded wires are available for use with the distractor.

Distract the joint (**FIGURE 17**) and remove articular cartilage using curette, rongeur or small osteotome.

A K-wire can be placed across the talo-navicular joint to stabilize the joint.



FIGURE 17

### 2.2 TRIAL IMPLANTS

Use the trial Presslock® universal Fusion plates to determine the appropriate shape and size (**FIGURE 18**).

Depending on the joint anatomy, 1 or 2 Straight plates or 1 H plate can be used, all available in Short, Medium or Long sizes.

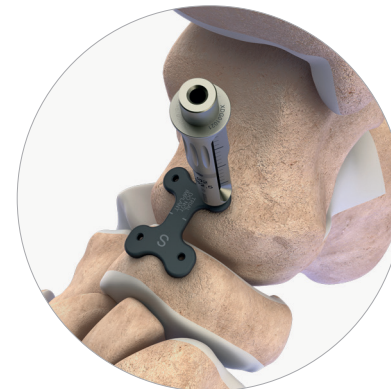

FIGURE 18



PRESSLOCK®  
H PLATES



PRESSLOCK®  
STRAIGHT PLATES

### 2.3 INTER-FRAGMENTARY COMPRESSION SCREW INSERTION

Insert a Ø1.4mm K-wire from the navicular to the talus and determine the screw length using the depth gauge. (FIGURE 20).

#### OPTION 1 : SELF-DRILLING SCREW

Use the T10 screwdriver tip to insert the Ø4mm compressive screw manually (using a driver handle) or with a power tool. Check to ensure proper stability at the osteotomy site (FIGURE 21).

#### OPTION 2 : PRE-DRILLING AND COUNTERSINK

Prepare bone housing using the dedicated Ø 2.7 mm drill bit and Ø3.7 countersinking reamer. Insert the screw with the T10 screwdriver tip (FIGURE 22).

**NOTE:** Replace the Nexis® Ø4mm screw with the PECA® Compressive Ø4mm screw to allow maximization of cortical anchorage and preservation of soft tissues thanks to the bevelled head. In this case, be sure to use the associated instrumentation: the Exact-T®10 screwdriver tip and, if necessary, the PECA® 4 Ø3.2mm AO drill bit and the Nexis® / PECA® 4 Ø3.7mm countersink.

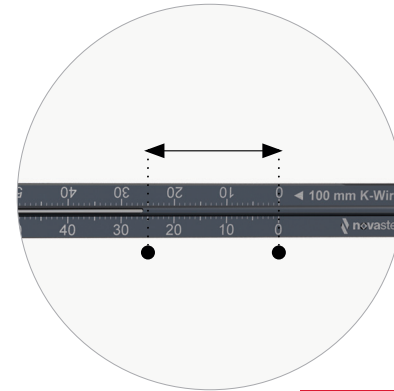

FIGURE 20

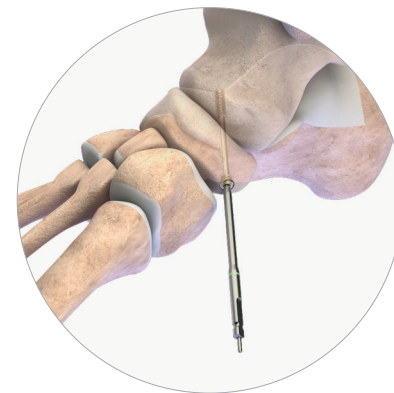

FIGURE 21



FIGURE 22

## 2.4 PLATE POSITIONING

Position the Presslock® universal Fusion plate according to the patient's anatomy. Secure the plate with temporary fixation pin (FIGURE 23).

### SCREW INSERTION

The steps for inserting Airlock® screws and the use of associated instruments are specified in p. 11 to 15.

#### UNIVERSAL HOLE Ø3.5MM SCREW INSERTION

Prepare the screw hole using either the locking drill guide for locking screws or the polyaxial drill guide for non-locking screws. Determine the appropriate screw length by either directly reading through the windowed drill guide or using the depth gauge after removing the drill guide, and insert the appropriate screw.

#### PRESSLOCK® HOLE Ø3.5MM LOCKING SCREW INSERTION

Position the Presslock® drill guide into the compression locking Presslock® hole. Prepare the screw hole. Determine the appropriate screw length by either directly reading through the windowed drill guide or by using the depth gauge after removing the drill guide and insert the locking screw into the locking compression slot. Repeat these steps for the second Presslock® hole if a H-plate has been used. Check the construct stability and confirm placement using fluoroscopy (FIGURE 24).

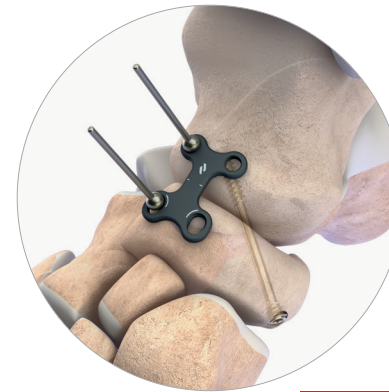

FIGURE 23

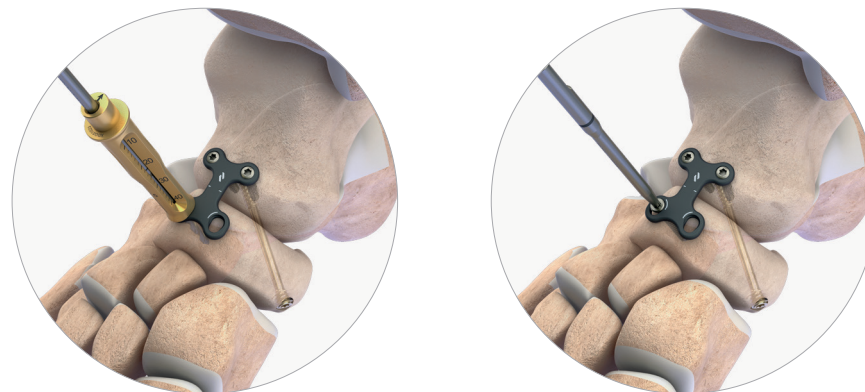

FIGURE 24

## 2.5 FINAL POSITIONING

See **FIGURE 25** for H plate final positioning or **FIGURE 26** straight plates final positioning.



FIGURE 25

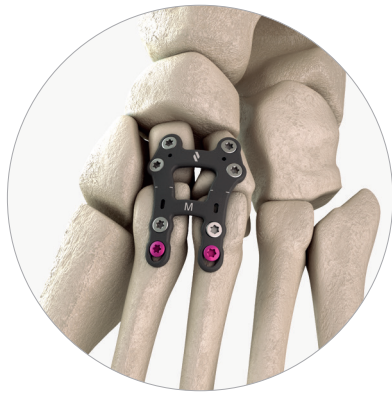

FIGURE 26

### 3. OTHER INDICATIONS

Regardless of the Airlock® plate used for different indications, follow the same steps for inserting Airlock® screws and the use of associated instruments specified in the Introduction.

#### 3.1 - LISFRANC ARTHRODESIS



LISFRANC H-PLATE



LISFRANC T-PLATE

#### 3.2 - LAPIDUS ARTHRODESIS



PRESSLOCK® LAPIDUS PLATE



PRESSLOCK® PLANTAR LAPIDUS PLATE



PRESSLOCK® FUSION STRAIGHT PLATES

### 3.3 CLOSING WEDGE OSTEOTOMY

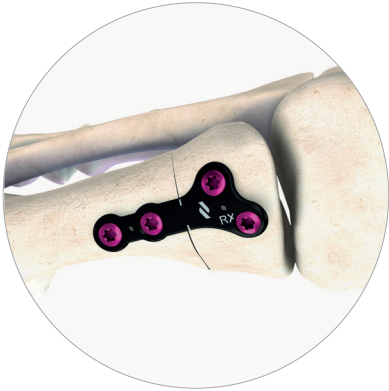

MT CLOSING WEDGE PLATE - OMM

### 3.5 NAVICULOCUNEIFORM ARTHRODESIS



PRESSLOCK® FUSION H PLATE

### 3.7- MALERBA OSTEOTOMY



PRESSLOCK® FUSION STRAIGHT PLATE

### 3.4 CALCANEOCUBOID ARTHRODESIS



PRESSLOCK® FUSION H PLATE

### 3.6- EVANS OSTEOTOMY



PRESSLOCK® FUSION H PLATE

### 3.8- DWYER OSTEOTOMY



PRESSLOCK® FUSION STRAIGHT PLATE

**MTP**

PART NO.	DESCRIPTION
PL010134 / PL010234	SHORT - RIGHT / LEFT
PL010140 / PL010240	MEDIUM - RIGHT / LEFT
PL010152 / PL010252	LONG - RIGHT / LEFT

**LISFRANC**

PART NO.	DESCRIPTION
PL050101	T - SHORT
PL050102	T - LONG
PL050201	H - SMALL
PL050202	H - MEDIUM
PL050203	H - LARGE

**UTILITY**

PART NO.	DESCRIPTION
PL040016	2 HOLES, LENGTH 16
PL040022	3 HOLES, LENGTH 22
PL040028	4 HOLES, LENGTH 28
PL040034	5 HOLES, LENGTH 34
PL040040	6 HOLES, LENGTH 40
PL040046	7 HOLES, LENGTH 46

**MT**

PART NO.	DESCRIPTION
PL020100 / PL020200	CLOSING WEDGE - RIGHT / LEFT
PL020103 / PL020203	OPEN WEDGE 3 - RIGHT / LEFT
PL020104 / PL020204	OPEN WEDGE 4 - RIGHT / LEFT
PL020105 / PL020205	OPEN WEDGE 5 - RIGHT / LEFT

**FUSION - PRESSLOCK®**

PART NO.	DESCRIPTION
PL040117	STRAIGHT - SHORT
PL040120	STRAIGHT - MEDIUM
PL040123	STRAIGHT - LONG
PL040217	H - SHORT
PL040220	H - MEDIUM
PL040223	H - LONG

**LAPIDUS - PRESSLOCK®**

PART NO.	DESCRIPTION
PL030301 / PL030302	SHORT - RIGHT / LEFT
PL030401 / PL030402	LONG - RIGHT / LEFT

**PLANTAR LAPIDUS - PRESSLOCK®**

PART NO.	DESCRIPTION
PL080101 / PL080102	SHORT - RIGHT / LEFT
PL080201 / PL080202	LONG - RIGHT / LEFT

## AIRLOCK® LOCKING SCREWS

PART NO.	DESCRIPTION
SP0130XX	Ø3MM
SP0135YY	Ø3.5MM

With XX from 10 to 30 in 2 mm increments.  
With YY from 10 to 40 in 2 mm increments.

## AIRLOCK® NON LOCKING SCREWS

PART NO.	DESCRIPTION
SP0230XX	Ø3MM
SP0235YY	Ø3.5MM

With XX from 10 to 30 in 2 mm increments.  
With YY from 10 to 40 in 2 mm increments.

## COMPRESSIVE SCREWS

PART NO.	LENGTH	SCREWS
SC0500XX	18 TO 60 mm	NEXIS® Ø4
SC060YYY	30 TO 100 mm	NEXIS® Ø5
PS0501XX	18 TO 60 mm	PECA®-C Ø4

With XX from 18 to 60 in 2 mm increments up to 50 and 5 mm increments up to 60.  
With YYY from 030 to 050 in 2 mm increments up to 50 and 5 mm up to 100.

## SCREWS COLOR CODE

COLOR	SCREW
●	AIRLOCK® Ø3
●	AIRLOCK® Ø3.5
●	NEXIS® Ø4
○	NEXIS® Ø5
●	PECA®-C Ø4

## K-WIRES &amp; POSITIONING PINS - AIRLOCK®

PART NO.	DESCRIPTION
XPP01003	SPHERICAL POSITIONING PIN
-	K-WIRE Ø1,4 LG 150 TR/RD <sup>(1)</sup>
-	K-WIRE Ø1,6 LG 150 TR/RD <sup>(2)</sup>
-	K-WIRE Ø1,6 LG 180 TR/RD <sup>(3)</sup>

<sup>(1)</sup>K-wire supplied separately - Medetechnik® K-wire (33-T10-R-14-150) or Novastep® K-wire (CKW01010) are available depending on your market.

<sup>(2)</sup>K-wire supplied separately - Medetechnik® K-wire (33-T10-R-16-150) or Novastep® K-wire (CKW01003) are available depending on your market.

<sup>(3)</sup>K-wire supplied separately - Medetechnik® K-wire (33-T10-R-16-180) or Novastep® K-wire (CKW01004) are available depending on your market.

## K-WIRES &amp; POSITIONING PINS - DISTRACTOR &amp; COMPRESSOR

PART NO.	DESCRIPTION
SKW04001	THREADED K-WIRE Ø2,5 - OPENING WEDGE DISTRACTOR - STERILE
SKW05003	THREADED K-WIRE Ø1,6 LG 140 TR/RD - STERILE
SKW05004	THREADED K-WIRE Ø2,5 LG 140 TR/RD - STERILE

AIRLOCK® INSTRUMENTATION

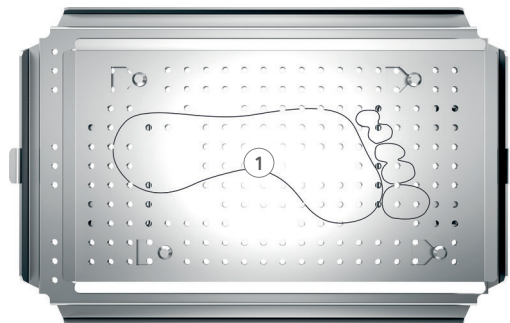
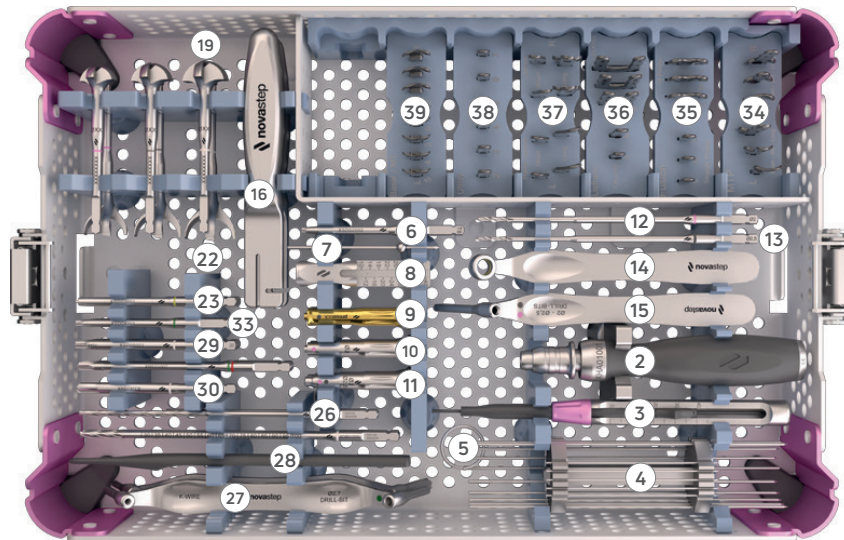

UNIVERSAL INSTRUMENTS

#	DESCRIPTION	PART NO.	QTY
-	TRAY	ACC1016P0001	1
-	LID	ACC1016P0003	1
1	FOOT SUPPORT PLATE	ACC1002P0008	1
2	AO HANDLE	XHA01001	1
3	DEPTH GAUGE	XGA01002	1
4	K-WIRE HOLDER	ACC1016P0004	1
-	K-WIRE Ø1,4 LG 150 TR/RD <sup>(1)</sup>	-	5
-	K-WIRE Ø1,6 LG 180 TR/RD <sup>(2)</sup>	-	5
5	CLEANING PIN Ø1.4	XKW01002	1

<sup>(1)</sup>K-wire supplied separately - Medetechnik® K-wire (33-T10-R-14-150) or Novastep® K-wire (CKW01010) are available depending on your market.

<sup>(2)</sup>K-wire supplied separately - Medetechnik® K-wire (33-T10-R-16-180) or Novastep® K-wire (CKW01004) are available depending on your market.

AIRLOCK® INSTRUMENTATION

#	DESCRIPTION	PART NO.	QTY
6	T8 AO SCREWDRIVER TIP	XSD02002	2
7	SPHERIC POSITIONING PIN	XPP01003	2
8	SCREW LENGTH INDICATOR	XGA01003	1
9	PRESSLOCK® - DRILL GUIDE FOR SCREW Ø 3.5	XDG01023	1
10	OBLONG DRILL GUIDE FOR SCREW Ø3	XDG01022	2
11	LOCKING DRILL GUIDE FOR SCREW Ø3 AND Ø3.5	XDG01021	1
12	DRILL BIT Ø2	XDB01021	2
13	DRILL BIT Ø2.5	XDB01022	OPTION
14	DRILL GUIDE HOLDER	XMS01004	1
15	POLYAXIAL DRILL GUIDE FOR SCREW Ø3 AND Ø3.5	XDG01020	1

## REAMERS &amp; PLATE BENDERS

#	DESCRIPTION	PART NO.	QTY
16	PLATE BENDERS	XMS01010	2
17	CONVEX REAMER Ø18	XRE01010	1
18	CONVEX REAMER Ø20	XRE01005	1
19	CONVEX REAMER Ø22	XRE01006	1
20	CONCAVE REAMER Ø18	XRE01011	1
21	CONCAVE REAMER Ø20	XRE01003	1
22	CONCAVE REAMER Ø22	XRE01004	1

## NEXIS® INSTRUMENTATION

#	DESCRIPTION	PART NO.	QTY
23	SNAP-OFF SCREWDRIVER TIP	XSD03001	1
24	T10 AO SCREWDRIVER TIP	XSD04001	1
25	COUNTERSINK	XRE01007	1
26	CANNULATED DRILL BIT Ø2.7	XDB01007	1
27	DOUBLE DRILL GUIDE FOR Ø4 SCREWS	XDG01009	1
28	RULER LG 150	XGA01009	1
29	T20 AO SCREWDRIVER TIP	XSD05001	OPTION
30	COUNTERSINK Ø4.9	XRE01008	OPTION
31	CANNULATED DRILL BIT Ø3.2	XBD01009	OPTION
32	DOUBLE DRILL GUIDE FOR SCREWS Ø5	XDG01015	OPTION

## PECA®-C INSTRUMENTATION

#	DESCRIPTION	PART NO.	QTY
33	EXACT2-T15 AO SCREWDRIVER TIP	XSD09002	OPTION
-	AO DRILL BIT Ø3.2	XDB01030	OPTION
-	K-WIRE Ø1,6 LG 150 TR/RD <sup>(3)</sup>	-	OPTION

<sup>(3)</sup>K-wire supplied separately - Medetechnik® K-wire (33-T10-R-16-150) or Novastep® K-wire (CKW01003) are available depending on your market.

## MTP TRIAL PLATES

#	DESCRIPTION	PART NO.	QTY
34	TRIAL PLATE HOLDER	ACC1006P0009	1
-	MTP MEDIUM TRIAL PLATE LEFT	XTI01001	1
-	MTP MEDIUM TRIAL PLATE RIGHT	XTI01002	1
-	MTP SHORT TRIAL PLATE LEFT	XTI01301	1
-	MTP SHORT TRIAL PLATE RIGHT	XTI01302	1
-	MTP LONG TRIAL PLATE LEFT	XTI01401	1
-	MTP LONG TRIAL PLATE RIGHT	XTI01402	1

## FUSION TRIAL PLATES

#	DESCRIPTION	PART NO.	QTY
35	TRIAL PLATE HOLDER	ACC1006P0007	1
-	FUSION STRAIGHT SHORT TRIAL PLATE	XTI04117	1
-	FUSION STRAIGHT MEDIUM TRIAL PLATE	XTI04120	1
-	FUSION STRAIGHT LONG TRIAL PLATE	XTI04123	1
-	FUSION H SMALL TRIAL PLATE	XTI04217	1
-	FUSION H MEDIUM TRIAL PLATE	XTI04220	1
-	FUSION H LONG TRIAL PLATE	XTI04223	1

## LISFRANC TRIAL PLATES

#	DESCRIPTION	PART NO.	QTY
36	TRIAL PLATE HOLDER	ACC1006P0012	1
-	LISFRANC H SMALL TRIAL PLATE	XTI05010	1
-	LISFRANC H MEDIUM TRIAL PLATE	XTI05020	1
-	LISFRANC H LARGE TRIAL PLATE	XTI05030	1
-	LISFRANC T SHORT TRIAL PLATE	XTI05040	1
-	LISFRANC T LONG TRIAL PLATE	XTI05050	1

## UTILITY TRIAL PLATES

#	DESCRIPTION	PART NO.	QTY
38	TRIAL PLATE HOLDER	ACC1006P0010	1
-	UTILITY 2 HOLES TRIAL PLATE	XTI04016	1
-	UTILITY 3 HOLES TRIAL PLATE	XTI04022	1
-	UTILITY 4 HOLES TRIAL PLATE	XTI04028	1
-	UTILITY 5 HOLES TRIAL PLATE	XTI04034	1
-	UTILITY 6 HOLES TRIAL PLATE	XTI04040	1
-	UTILITY 7 HOLES TRIAL PLATE	XTI04046	1

## LAPIDUS TRIAL PLATES

#	DESCRIPTION	PART NO.	QTY
37	TRIAL PLATE HOLDER	ACC1006P0011	1
-	LAPIDUS SHORT TRIAL PLATE RIGHT	XTI03301	1
-	LAPIDUS SHORT TRIAL PLATE LEFT	XTI03302	1
-	LAPIDUS LONG TRIAL PLATE RIGHT	XTI03401	1
-	LAPIDUS LONG TRIAL PLATE LEFT	XTI03402	1
-	PLANTAR LAPIDUS SHORT TRIAL PLATE RIGHT	XTI08101	1
-	PLANTAR LAPIDUS SHORT TRIAL PLATE LEFT	XTI08102	1
-	PLANTAR LAPIDUS LONG TRIAL PLATE RIGHT	XTI08201	1
-	PLANTAR LAPIDUS LONG TRIAL PLATE LEFT	XTI08202	1

## MT BASE TRIAL PLATES - OPTION

#	DESCRIPTION	PART NO.	QTY
39	TRIAL PLATE HOLDER	ACC1006P0008	1
-	MT CLOSING WEDGE TRIAL PLATE LEFT	XTI02010	1
-	MT OPEN WEDGE 3 TRIAL PLATE LEFT	XTI02013	1
-	MT OPEN WEDGE 4 TRIAL PLATE LEFT	XTI02014	1
-	MT OPEN WEDGE 5 TRIAL PLATE LEFT	XTI02015	1
-	MT CLOSING WEDGE TRIAL PLATE RIGHT	XTI02020	1
-	MT OPEN WEDGE 3 TRIAL PLATE RIGHT	XTI02023	1
-	MT OPEN WEDGE 4 TRIAL PLATE RIGHT	XTI02024	1
-	MT OPEN WEDGE 5 TRIAL PLATE RIGHT	XTI02025	1

Optional, the Distractor & Compressor tray can be added to the Airlock® platform. Used together or separately, these instrument trays allow a comprehensive approach to the various indications of foot surgery.

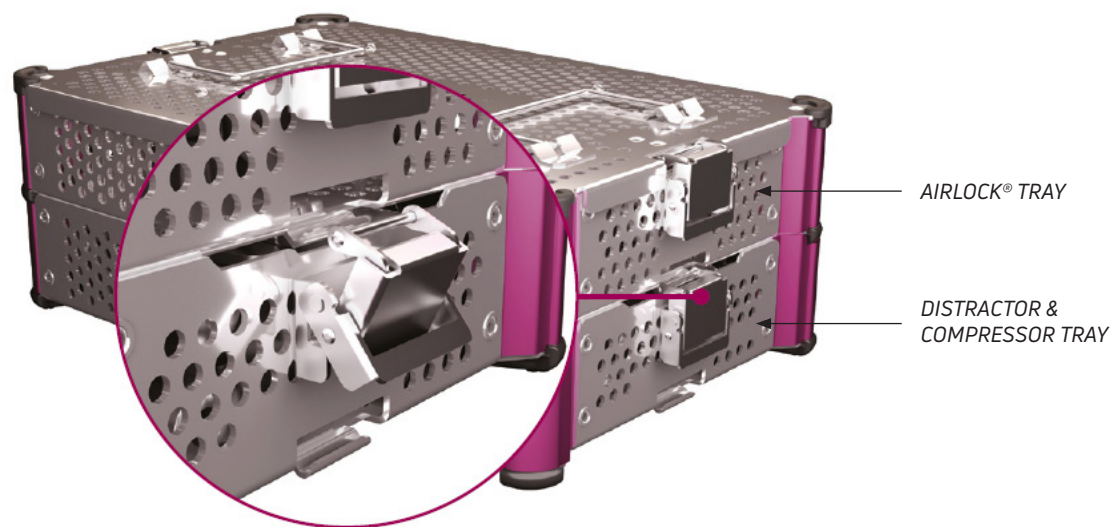

ATTACHMENT SYSTEM

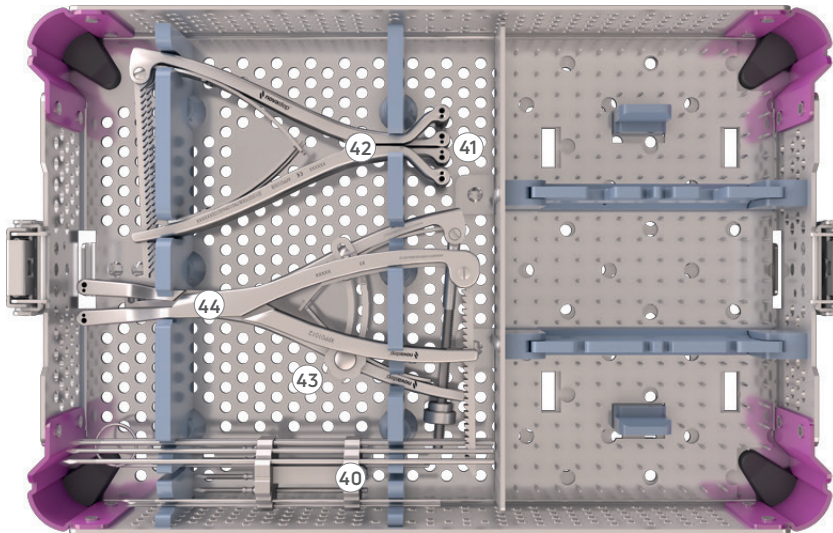

## DISTRACTOR & COMPRESSOR TRAY - OPTIONAL

#	DESCRIPTION	PART NO.	QTY
-	DISTRACTOR TRAY	ACC1016P0002	1
40	DISTRACTOR K-WIRES HOLDER	ACC1016P0005	1
-	THREADED K-WIRE Ø2,5 - OPENING WEDGE DISTRACTOR - STERILE <sup>(1)</sup>	SKW04001	4
-	THREADED K-WIRE Ø1,6 LG 140 TR/RD - STERILE <sup>(1)</sup>	SKW05003	5
-	THREADED K-WIRE Ø2,5 LG 140 TR/RD - STERILE <sup>(1)</sup>	SKW05004	5
41	CLOSED ARMS DISTRACTOR	XFP01006	1
42	OPEN ARMS DISTRACTOR	XFP01008	1
43	OPENING WEDGE DISTRACTOR	XFP01011	1
44	COMPRESSIVE FORCEPS	XFP01012	1

<sup>(1)</sup>Threaded k-wire supplied separately.



**enovis**

T +33 (0) 2 99 33 86 50 F + 33 (0) 9 70 29 18 95

Legal manufacturer: Novastep® S.A.S  
2 Allée Jacques Frimot | 35000 Rennes | France  
contact-intfa@enovis.com  
www.int.novastep.life

Copyright © 2024 Enovis Foot and Ankle

Carefully read the enclosed Instructions For Use (IFU) and all packaging label information. Devices: Implants: Class IIb-CE1639 / Instruments: Class I / Class Ir-CE1639 / Class IIa-CE1639.

REFERENCE: AIR-ST-ED8-02-26-EN